

BONENG



0.25kW~3kW

**K斜齿锥齿轮马达
变频驱动一体机**

**K Helical-bevel
Gearmotor Variable
Frequency Drive
All-in-one**

Edit date 04/2023

Selection Catalogue: C05.0052-CN/EN

Boneng Transmission



控制器/驱动器/马达/
齿轮马达/齿轮箱

Controller/ Drive/ Motor/
Gearmotor/ Gearbox

选型注意事项:

- ◆ 结构示意图、外形图及其他附图只属范例，无严格比例要求。（未注尺寸单位均为mm）。
- ◆ 所注重量仅为平均值，并不具有约束力。
- ◆ 注油量只作为参考值，实际注油量应以油镜上的标记为准。

⚠ 使用注意事项

- ◆ 为防止意外事故发生，所有旋转部件均按照使用者所在国家和地区的安全规范由购置方加罩保护。
- ◆ 试车之前必须认真阅读使用说明书。
- ◆ 齿轮马达在供货时已处于准运行状态，运行前需加注润滑油。
- ◆ 齿轮马达应由熟悉相关安全要求的专业人员安装；安装时必须有安全装置以防止事故发生，安装位置必须符合规定。

Note:

- ◆ The structure scheme, appearance diagram and other attached diagrams in sample are examples, there is no strict proportion requirement. (The unmarked dimension units are mm).
- ◆ The marked weight is average value, it has no constraint force.
- ◆ The marked oil quantity in sample is only reference value, actual oil filling quantity should be the same with the mark on oil immersion lens.

⚠ You must confirm to the following instructions

- ◆ To prevent accidents, all the rotation parts are added with protective covers according to the safety regulations of the nation and region.
- ◆ Before debugging, you should carefully read instruction book.
- ◆ Gearmotor is on running-permission status when delivered, you should add lubrication oil before putting it into running.
- ◆ The gearmotor should be installed by technical staffs who could be familiar with corresponding security requirements. Security device should be required for preventing from accidents while installation position must be satisfied with regulations.

目录

Contents

01.概述	01	01.Overview	01
02.产品特性	01	02.Characteristics	01
03.优势特点	04	03.Advantages	04
04.型号表示方法	05	04.Type Designation	05
05.传动能力表	07	05.Transmission Capacity	07
06.外形尺寸图	15	06.Dimensions	15
07.允许的输出轴径向力表	27	07.Permissible Radial Force of Output Shaft	27
08.被驱动轴推荐尺寸	28	08.Recommended Dimensions for Driven Equipment Shaft	28
09.轴端中心孔尺寸	30	09.Dimensions of Shaft End Centre Hole	30
10.平键与键槽的尺寸	31	10.Dimension of Parallel Key and Keyway	31
11.可选附件和指定配置	32	11.Accessories and Specific Configuration	32
12.润滑油	34	12.Oil	34
13.重量表	34	13.Weight	34

1.概述

齿轮马达变频驱动一体机是基于分布式应用的齿轮马达、驱动器一体式产品，搭配全封闭自扇冷却三相交流异步马达，设计生产符合ISO、IEC、GB等相关标准的要求。适用于连续工作制(S1)、恒转速或一定速度范围内的变频调速应用，同时也满足大部分断续工作方式(S2-S10)。

该一体机系统专门针对输送带、分拣系统、行李和货物运输系统、仓库和配送物流、邮件分拣以及包裹配送等应用中的节能和成本效益水平运动进行了优化。可广泛应用于多机水平输送等行业，以及对防护等级有较高要求的电气传动场合。

2.产品特性

2.1.技术特性

- ◆ 颜色：银色RAL9006
- ◆ 马达额定功率：0.25kW~3kW；
- ◆ 马达极数：4；
- ◆ 马达效率：达到GB18613-2020标准能效等级3级，且满足IEC 60034-30标准中的IE2和IE3效率等级；
- ◆ 马达防护等级：防护等级为IP55；
- ◆ 马达绝缘等级：绝缘系统按155°C (F) 温度等级设计，按130°C (B) 温度等级考核；
- ◆ 马达冷却方式：马达标准冷却方式为IC411自扇冷却。
- ◆ 支持SVC(开环矢量)控制、VF控制
- ◆ 可实现速度控制与转矩控制
- ◆ 支持Modbus通讯、EtherCAT通讯
- ◆ 支持本地上位机连接

2.2.运行环境

- ◆ 高度不超过海拔1000m；
- ◆ 允许的环境温度在-20°C ~ 40°C；
- ◆ 所允许的相对湿度：
 - 20°C ≤ T ≤ 20°C：100%
 - 20°C < T ≤ 30°C：95%
 - 30°C < T ≤ 40°C：55%

1.Overview

Gearmotor variable frequency drive all-in-one is based on distributed application and equipped with totally enclosed fan cooled three-phase asynchronous motor. Its design and production meet the requirements of ISO, IEC, GB and other related standards. The integrated machine is applicable for continuous running duty (S1), constant speed and variable frequency speed control within a specific speed range. Also, it can meet most short-time duty (S2-S10).

The integrated machine system is optimized for energy conservation and cost performance in the field of conveyor belt, automatic sorting systems, baggage and cargo system, warehouse and distribution logistics, mail sorting, parcel delivery and other objects. It is widely used in multi-machine horizontal conveying and other industries, as well as electrical transmission occasions with higher requirements for protection levels.

2.Characteristics

2.1.Technical characteristics

- ◆ Motor color: silver RAL9006;
- ◆ Rated power: 0.25kW~3kW;
- ◆ Poles of motor:4;
- ◆ Motor efficiency: meet Grade 3 according to GB18613-2020 and IE2, IE3 according to IEC 60034-30
- ◆ Degree of protection : IP55
- ◆ Insulation class: the insulation system is designed for temperature class 155°C(F) and checked by temperature class 130°C(B);
- ◆ Cooling method: self-ventilated (IC411) as standard;
- ◆ Support SVC (open-loop vector) control and VF control;
- ◆ Realize speed control;
- ◆ Support Modbus communication and EtherCAT communication;
- ◆ Support local upper computer connection.

2.2.Operating environment

- ◆ Altitude shall not exceed 1000m above seal-level;
- ◆ Allowed temperature between -20°C and 40°C;
- ◆ Permitted relative humidity:
 - 20°C ≤ T ≤ 20°C：100%
 - 20°C ≤ T ≤ 30°C：95%
 - 30°C ≤ T ≤ 40°C：55%

2.3.驱动器规格参数

端口参数	
输出电源	外接24V电源 ● 24VDC±10%, 最大40mA
	外接10V电源 ● +10V-GND, 最大10mA
数字量输入	4通道共COM输入 ● DI0~DI3, 光耦隔离, 支持双向输入
	● 输入电压 12VDC~30VDC
模拟量输入	1通道输入 ● 电压型: DC 0~10V ● 精度1%
LED指示灯	2个双色指示 ● 运行、故障、通信状态指示
通讯端口	RS485通讯 或以太网通讯 ● Modbus RTU 格兰头接口 ● EtherCAT 航空插头
	PC通讯接口 ● RS485通讯, 特制端口 ● 支持PC上位机调试及软件更新

2.3 Drive specification parameters

Port parameters	
Output power supply	External 24V power supply ● 24VDC±10%, max. 40mA
	External 10V power supply ● +10V-GND, max. 10mA
Digital input	4 channels COM input ● DI0~DI3, opto-isolator, support bidirectional input
	● Input voltage: 12VDC~30VDC
Analog input	1 channel input ● Voltage type: DC 0~10V ● Precision: 1%
LED indicator	2 two-color indicator lights ● Indication of running, failure and communication status
Communication port	RS485 communication or EtherCAT communication ● ModBus RTU cable gland port ● EtherCAT aviation plug
	PC communication port ● RS485 communication, Special purpose port
	● Support PC uppercomputer debugging and software update

功率参数 (通用参数)	
输入电压	380...480V 3AC ±10%
输入频率	47...63Hz
输出频率	0...300Hz 50Hz不降容, <50Hz参见降容曲线
载波频率	4kHz (标准)
功率因素	0.95
控制器效率	95...97%
过载能力	1.2倍额定输出电流1min, 1.5倍额定输出电流3sec, 周期10min
电磁兼容	可选符合EN 55011 标准的A级和B级滤波器
防护等级	IP55
工作温度	-20...+40℃不降容, >40...60℃, 参见降容曲线
标准SCCR	10kA
保护功能	● 欠电压
	● 过电压
	● 过载
	● 短路
	● 电机失速保护
	● 电机过载
	● 变频器过温

Power parameter (common parameters)	
Input voltage	380~480V, 3AC, ±10%
Input frequency	47~63Hz
Output frequency	0~300Hz (see the derating curve when frequency less than 50Hz)
Carrier frequency	4kHz (standard)
Power factor	0.95
Efficiency of controller	95~97%
Overload capability	1.2 times rated output current for 1min, 1.5 times rated output current for 3 s within a cycle time of 10min
Electromagnetic compatibility	Class A and B filters are available according to EN 55011
Protection grade	IP55
Operating temperature	-20~+40℃: no derating; 40~60℃: see the derating curve
Standard SCCR	10kA
Defensive function	Under voltage
	Over voltage
	Overload
	Short circuit
	Mortor stall protection
	Motor overload
	Inverter over temperature

2.4.驱动器特性曲线

电流降容 · 环境温度

2.4 Drive characteristic curve

Current derating · environment temperature

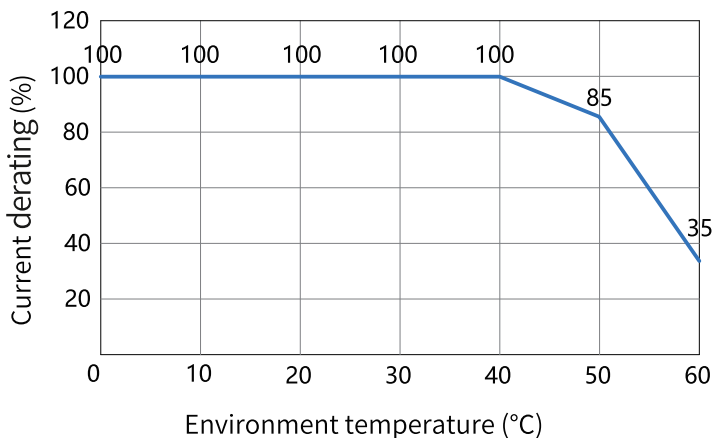

电流降容 · 海拔高度

Current derating · altitude

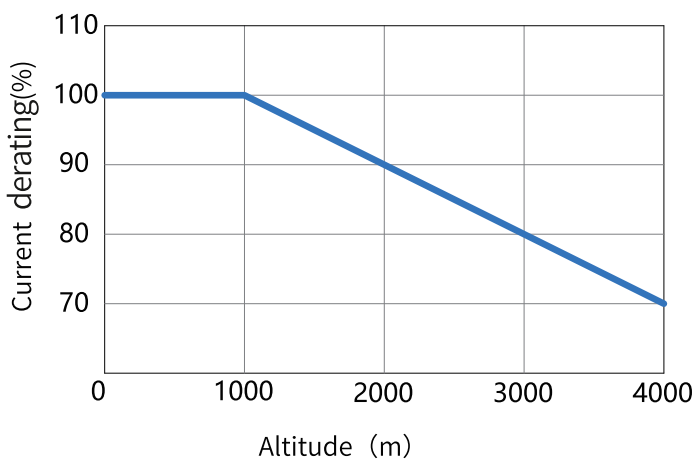

电流降容 · 输出频率

Current derating · output frequency

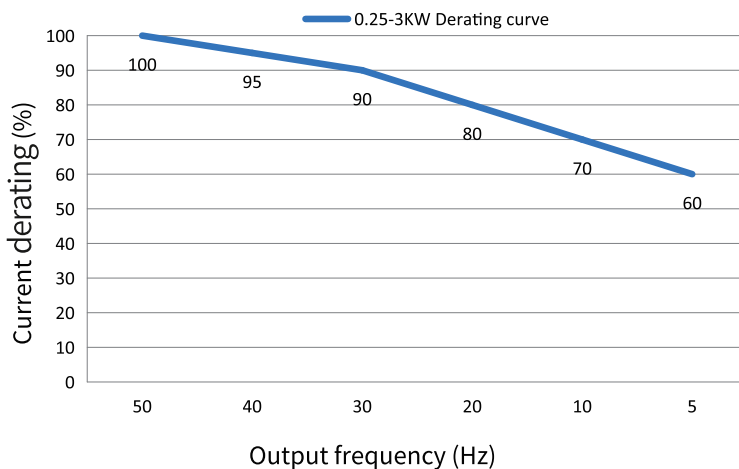

3. 优势特点

(1) 用户友好

安装灵活	具备多方向进线、多方位安装，匹配客户环境需求
参数拷贝	调试一台驱动器，通过PC软件拷贝到其他驱动器
参数分组	功能码合理分组，参数简单直观，方便理解
支持Boneng Drivesoft 软件	参数显示及修改，虚拟示波器，已修改参数等功能方便调试
选配电位器	带电位器旋钮，实现无极调速

(2) 品质可靠

高质量电子元件/电容器	使用寿命更长
所有变频器出厂前进行满负荷测试	可靠性高
完善的驱动器保护功能	平均无故障时间长
带涂层线路板，防潮、防腐蚀外壳	适应更恶劣环境

(3) 性能卓越

过程比例积分(PID)控制器	无需外部控制器
自动识别电机模型	发挥电机的全部潜能
随载随速	轻载高速 重载限速 提升工作效率
跟踪启动(跟踪自由旋转的电机)	避免启动冲击
支持参数互联	参数可互联到P组，可实现启停来源，速度来源等选择来自P组参数，极其灵活
支持自由功能块	支持逻辑，算术运算，延时，数据选择，适用特殊工况参数设置

(4) 成本节约

由于无需机柜和长距离电机电缆，可以节省成本，且系统设计外观漂亮。

3. Advantages

(1) User-friendliness

Flexible installation	With multi-directional cable entry and multi-direction installation, it meet the customer environmental requirements
Parameter copy	Debug a drive and copy it to another drive using PC software
Grouping of parameters	Function code is grouped reasonably and parameters are simple and intuitive for understanding
Support Boneng Drivesoft software	Parameter display and modification, virtual oscilloscope, modified parameters and other functions are convenient for debugging
Optional potentiometer	Stepless speed regulation is achieved with potential knob to achieve

(2) Reliable quality

High quality electronic components/capacitor	Longer service life
All frequency converters are tested at full load before leaving the factory	high reliability
Complete drive protection function	Longer mean time between failures
Coated circuit board, damp and corrosion proof housing	Adapt to the harsher environment

(3) Superior performance

Process proportional integral controller (PID)	No external controller required
Automatic identification of motor models	Develop the full potential of the motor
Following load and speed	Light load with high speed, heavy load with limited speed, thereby improving work efficiency
Trace startup (track freely spinning motors)	Avoid start-up shocks
Support parameter interconnection	The parameters can be interconnected to the P group and realize the parameter selection from the P group such as the start and stop source, the speed source, etc., which is extremely flexible
Support free function modules	Support logic, arithmetic operation, delay, data selection and special working conditions parameter setting

(4) Cost saving

Without cabinets and long-distance motor cables, costs are saved and the system design looks great.

4.型号表示方法

系列名
传动级数
 3级
机座号
安装形式
 H=底脚安装
 F=法兰安装
 S=小法兰安装
 A=轴装式安装
 T=带底面扭力臂附件安装
 M=带侧面扭力臂附件安装
输出形式
 A/B/D/E=单向平键实心轴
 C/F=双向平键实心轴
 G/H=平键空心轴
 I/J=锁紧盘空心轴
 K/L=渐开线花键空心轴
公称减速比代号
安装方位
 D1/D2/D3/D4/D5/D6

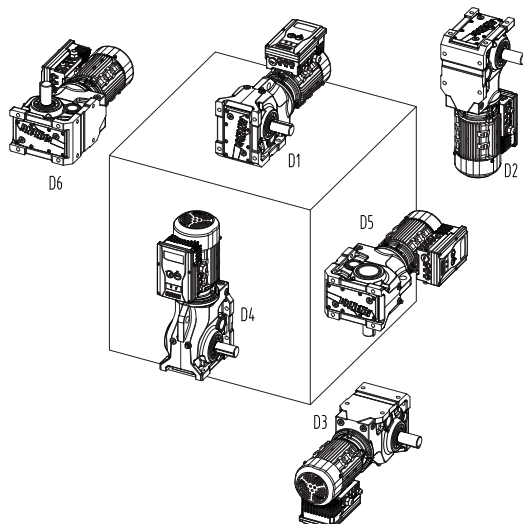

可选附件和指定配置
 0=无可选附件和指定配置
 1=齿轮非常规安装
 6=补偿油箱
 B=齿轮非常规安装和补偿油箱

润滑油代号
 0=不加润滑油 (不加油出厂时, 请选此项)
 1=矿物润滑油VG220 (环境温度 $-20^{\circ}\text{C}\sim+40^{\circ}\text{C}$, 需加油出厂时, 请选此项)
 5=合成润滑油VG220 (环境温度 $<0^{\circ}\text{C}$, 需加油出厂时, 推荐选用此项)

4.Type Designation

Series
Stages
 3-stage
Size
Mounting Mode
 H=Horizontal foot-mounted
 F=Flange-mounted
 S=Short flange-mounted
 A=Shaft-mounted
 T=Torque arm-mounted with bottom accessory
 M=Torque arm-mounted with side accessory
Output Mode
 A/B/D/E=Unidirectional output shaft
 C/F=Bidirectional output shaft
 G/H=Hollow shaft with parallel key
 I/J=Hollow shaft with shrink disk
 K/L=Hollow shaft with involute spline
Nominal Ratio Code
Mounting Positions
 D1/D2/D3/D4/D5/D6

K 3 04 H A - C56 - D1 0 1 -

Accessories and Specific Configuration

0=None
 1=Unconventional installation of gear
 6=Oil compensating tank
 B=Unconventional installation of gear and oil compensating tank

Oil Code

0=Without oil filling(Please select this option when you do not need lubricating oil)
 1=With mineral oil VG220(Please select this option when the ambient temperature is $-20^{\circ}\text{C}\sim+40^{\circ}\text{C}$)
 5=With synthetic lubricating oil VG220(It is recommended to select this option when you need lubricating oil and the ambient temperature is below 0°C)

MH080M4A75 A L 2 - D 0 EC 0 - 0 1 1

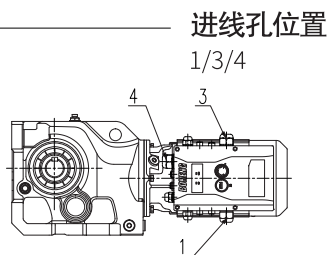

进线孔位置

1/3/4

Cable entry location

1/3/4

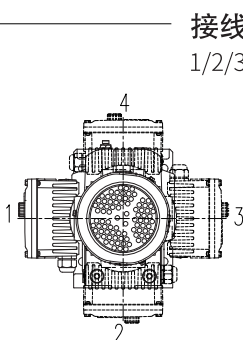

接线盒位置

1/2/3/4

Terminal box location

1/2/3/4

马达安装方位 0

Motor mounting position 0

一体机防护等级

0=IP55

1=IP55和防雨罩

Protection degree

0=IP55

1=IP55+Rain cover

通讯协议

MB=Modbus RTU

EC=EtherCAT

Communication protocol

MB=Modbus RTU

EC=EtherCAT

调速旋钮 1)

0=无调速旋钮

1=有调速旋钮

Speed control knob 1)

0=No speed control knob

1=Speed control knob

驱动器

D=分布式

Drive

D=Distributed

频率/电压代号

2=47~63Hz/380~480V

Code of voltage and frequency

2=47~63Hz/380~480V

机座材质

L=铝机座

Cast-aluminum frame

L=Aluminum

安装形式A

Construction type A

功率 (kW)	MH=IE2三相交流异步马达4极规格 MP=IE3三相交流异步马达4极规格		
Power(kw)	MH=IE2 4-pole three-phase asynchronous motor MP=IE3 4-pole three-phase asynchronous motor		
0.25	MH071M4A25... MP071M4A25...	1.1	MH090S4B11... MP090S4B11...
0.37	MH071M4A37... MP071M4A37...	1.5	MH090S4B15... MP090M4B15...
0.55	MH080M4A55... MP080M4A55...	2.2	MH100M4B22... MP100M4B22...
0.75	MH080M4A75... MP080M4A75...	3	MH100M4B30... MP100M4B30...

5.传动能力表

5.Transmission Capacity

马达 额定功率	马达 额定转速	减速机实际 输出转速	减速机实际 输出扭矩	减速机公称 减速比代号	减速机公称 减速比	减速机精确 减速比	减速机额定 输出扭矩	服务系数	通讯方式	订货号
Motor Rated Power	Motor Rated Speed	Actual Output Speed of Gearmotor	Actual Output Torque of Gearmotor	Nominal Ratio Code of Gearmotor	Nominal Ratio of Gearmotor	Exact Ratio of Gearmotor	Normal Output Torque of Gearmotor	Service Coefficient	Communication Mode	Order Code
P_{IN} (kw)	n_{IN} (r/min)	n_{2N} (r/min)	T_2 (N.m)	Code	i_N	i_{ex}	T_{2N} (N.m)	f		
0.25	1380	349	6.7	B40	4	3.95	150	22.39	MB/EC	K303□□-B40-D□□□-□□071□4A25AL□-D□□□□-0□□
0.25	1380	309	7.6	B45	4.5	4.46	150	19.74	MB/EC	K303□□-B45-D□□□-□□071□4A25AL□-D□□□□-0□□
0.25	1380	272	8.6	B50	5	5.08	150	17.44	MB/EC	K303□□-B50-D□□□-□□071□4A25AL□-D□□□□-0□□
0.25	1380	240	9.8	B56	5.6	5.74	160	16.33	MB/EC	K303□□-B56-D□□□-□□071□4A25AL□-D□□□□-0□□
0.25	1380	215	11	B63	6.3	6.42	180	16.36	MB/EC	K303□□-B63-D□□□-□□071□4A25AL□-D□□□□-0□□
0.25	1380	191	12	B71	7.1	7.24	180	15	MB/EC	K303□□-B71-D□□□-□□071□4A25AL□-D□□□□-0□□
0.25	1380	167	14	B80	8	8.25	180	12.86	MB/EC	K303□□-B80-D□□□-□□071□4A25AL□-D□□□□-0□□
0.25	1380	148	16	B90	9	9.33	180	11.25	MB/EC	K303□□-B90-D□□□-□□071□4A25AL□-D□□□□-0□□
0.25	1380	130	18	C10	10	10.6	180	10	MB/EC	K303□□-C10-D□□□-□□071□4A25AL□-D□□□□-0□□
0.25	1380	121	19	C11	11.2	11.4	180	9.47	MB/EC	K303□□-C11-D□□□-□□071□4A25AL□-D□□□□-0□□
0.25	1380	109	22	C13	12.5	12.7	180	8.18	MB/EC	K303□□-C13-D□□□-□□071□4A25AL□-D□□□□-0□□
0.25	1380	96.5	24	C14	14	14.3	200	8.33	MB/EC	K303□□-C14-D□□□-□□071□4A25AL□-D□□□□-0□□
0.25	1380	84.7	28	C16	16	16.3	200	7.14	MB/EC	K303□□-C16-D□□□-□□071□4A25AL□-D□□□□-0□□
0.25	1380	75	31	C18	18	18.4	210	6.77	MB/EC	K303□□-C18-D□□□-□□071□4A25AL□-D□□□□-0□□
0.25	1380	66.3	35	C20	20	20.8	220	6.29	MB/EC	K303□□-C20-D□□□-□□071□4A25AL□-D□□□□-0□□
0.25	1380	61.6	38	C22	22.4	22.4	225	5.92	MB/EC	K303□□-C22-D□□□-□□071□4A25AL□-D□□□□-0□□
0.25	1380	53.9	44	C25	25	25.6	230	5.23	MB/EC	K303□□-C25-D□□□-□□071□4A25AL□-D□□□□-0□□
0.25	1380	50	47	C28	28	27.6	230	4.89	MB/EC	K303□□-C28-D□□□-□□071□4A25AL□-D□□□□-0□□
0.25	1380	42.9	55	C32	31.5	32.2	230	4.18	MB/EC	K303□□-C32-D□□□-□□071□4A25AL□-D□□□□-0□□
0.25	1380	38	62	C36	35.5	36.3	230	3.71	MB/EC	K303□□-C36-D□□□-□□071□4A25AL□-D□□□□-0□□
0.25	1380	33.4	70	C40	40	41.3	230	3.29	MB/EC	K303□□-C40-D□□□-□□071□4A25AL□-D□□□□-0□□
0.25	1380	29.6	79	C45	45	46.7	230	2.91	MB/EC	K303□□-C45-D□□□-□□071□4A25AL□-D□□□□-0□□
0.25	1380	26.1	90	C50	50	52.9	230	2.56	MB/EC	K303□□-C50-D□□□-□□071□4A25AL□-D□□□□-0□□
0.25	1380	24.2	97	C56	56	57	230	2.37	MB/EC	K303□□-C56-D□□□-□□071□4A25AL□-D□□□□-0□□
0.25	1380	20.7	113	C63	63	66.7	230	2.04	MB/EC	K303□□-C63-D□□□-□□071□4A25AL□-D□□□□-0□□
0.25	1380	18.3	129	C71	71	75.6	230	1.78	MB/EC	K303□□-C71-D□□□-□□071□4A25AL□-D□□□□-0□□
0.25	1380	16.6	142	C80	80	83.3	230	1.62	MB/EC	K303□□-C80-D□□□-□□071□4A25AL□-D□□□□-0□□
0.25	1380	15.1	155	C90	90	91.1	230	1.48	MB/EC	K303□□-C90-D□□□-□□071□4A25AL□-D□□□□-0□□
0.25	1380	13.9	169	D10	100	99.6	230	1.36	MB/EC	K303□□-D10-D□□□-□□071□4A25AL□-D□□□□-0□□

马达 额定功率	马达 额定转速	减速机实际 输出转速	减速机实际 输出扭矩	减速机公称 减速比代号	减速机公称 减速比	减速机精确 减速比	减速机额定 输出扭矩	服务系数	通讯方式	订货号
Motor Rated Power	Motor Rated Speed	Actual Output Speed of Gearmotor	Actual Output Torque of Gearmotor	Nominal Ratio Code of Gearmotor	Nominal Ratio of Gearmotor	Exact Ratio of Gearmotor	Normal Output Torque of Gearmotor	Service Coefficient	Communication Mode	Order Code
P_{IN} (kw)	n_{IN} (r/min)	n_{2N} (r/min)	T_2 (N.m)	Code	i_N	i_{ex}	T_{2N} (N.m)	f		
0.37	1385	351	10	B40	4	3.95	150	15	MB/EC	K303□□-B40-D□□□-□□071□4A37AL□-D□□□□-0□□□
0.37	1385	311	12	B45	4.5	4.46	150	12.5	MB/EC	K303□□-B45-D□□□-□□071□4A37AL□-D□□□□-0□□□
0.37	1385	273	13	B50	5	5.08	150	11.54	MB/EC	K303□□-B50-D□□□-□□071□4A37AL□-D□□□□-0□□□
0.37	1385	241	15	B56	5.6	5.74	160	10.67	MB/EC	K303□□-B56-D□□□-□□071□4A37AL□-D□□□□-0□□□
0.37	1385	216	17	B63	6.3	6.42	180	10.59	MB/EC	K303□□-B63-D□□□-□□071□4A37AL□-D□□□□-0□□□
0.37	1385	191	19	B71	7.1	7.24	180	9.47	MB/EC	K303□□-B71-D□□□-□□071□4A37AL□-D□□□□-0□□□
0.37	1385	168	21	B80	8	8.25	180	8.57	MB/EC	K303□□-B80-D□□□-□□071□4A37AL□-D□□□□-0□□□
0.37	1385	148	24	B90	9	9.33	180	7.5	MB/EC	K303□□-B90-D□□□-□□071□4A37AL□-D□□□□-0□□□
0.37	1385	131	28	C10	10	10.6	180	6.43	MB/EC	K303□□-C10-D□□□-□□071□4A37AL□-D□□□□-0□□□
0.37	1385	121	30	C11	11.2	11.4	180	6	MB/EC	K303□□-C11-D□□□-□□071□4A37AL□-D□□□□-0□□□
0.37	1385	109	33	C13	12.5	12.7	180	5.45	MB/EC	K303□□-C13-D□□□-□□071□4A37AL□-D□□□□-0□□□
0.37	1385	96.9	37	C14	14	14.3	200	5.41	MB/EC	K303□□-C14-D□□□-□□071□4A37AL□-D□□□□-0□□□
0.37	1385	85	42	C16	16	16.3	200	4.76	MB/EC	K303□□-C16-D□□□-□□071□4A37AL□-D□□□□-0□□□
0.37	1385	75.3	48	C18	18	18.4	210	4.38	MB/EC	K303□□-C18-D□□□-□□071□4A37AL□-D□□□□-0□□□
0.37	1385	66.6	54	C20	20	20.8	220	4.07	MB/EC	K303□□-C20-D□□□-□□071□4A37AL□-D□□□□-0□□□
0.37	1385	61.8	58	C22	22.4	22.4	225	3.88	MB/EC	K303□□-C22-D□□□-□□071□4A37AL□-D□□□□-0□□□
0.37	1385	54.1	67	C25	25	25.6	230	3.43	MB/EC	K303□□-C25-D□□□-□□071□4A37AL□-D□□□□-0□□□
0.37	1385	50.2	72	C28	28	27.6	230	3.19	MB/EC	K303□□-C28-D□□□-□□071□4A37AL□-D□□□□-0□□□
0.37	1385	43	84	C32	31.5	32.2	230	2.74	MB/EC	K303□□-C32-D□□□-□□071□4A37AL□-D□□□□-0□□□
0.37	1385	38.2	94	C36	35.5	36.3	230	2.45	MB/EC	K303□□-C36-D□□□-□□071□4A37AL□-D□□□□-0□□□
0.37	1385	33.5	107	C40	40	41.3	230	2.15	MB/EC	K303□□-C40-D□□□-□□071□4A37AL□-D□□□□-0□□□
0.37	1385	29.7	121	C45	45	46.7	230	1.9	MB/EC	K303□□-C45-D□□□-□□071□4A37AL□-D□□□□-0□□□
0.37	1385	26.2	138	C50	50	52.9	230	1.67	MB/EC	K303□□-C50-D□□□-□□071□4A37AL□-D□□□□-0□□□
0.37	1385	24.3	148	C56	56	57	230	1.55	MB/EC	K303□□-C56-D□□□-□□071□4A37AL□-D□□□□-0□□□
0.37	1385	20.8	173	C63	63	66.7	230	1.33	MB/EC	K303□□-C63-D□□□-□□071□4A37AL□-D□□□□-0□□□
0.37	1385	18.3	197	C71	71	75.6	230	1.17	MB/EC	K303□□-C71-D□□□-□□071□4A37AL□-D□□□□-0□□□
0.37	1385	16.6	217	C80	80	83.3	230	1.06	MB/EC	K303□□-C80-D□□□-□□071□4A37AL□-D□□□□-0□□□
0.37	1385	15.2	237	C90	90	91.1	230	0.97	MB/EC	K303□□-C90-D□□□-□□071□4A37AL□-D□□□□-0□□□
0.37	1385	13.9	259	D10	100	99.6	230	0.89	MB/EC	K303□□-D10-D□□□-□□071□4A37AL□-D□□□□-0□□□
0.37	1385	15	240	C90	90	92.4	450	1.88	MB/EC	K304□□-C90-D□□□-□□071□4A37AL□-D□□□□-0□□□
0.37	1385	13.3	270	D10	100	104.0	450	1.67	MB/EC	K304□□-D10-D□□□-□□071□4A37AL□-D□□□□-0□□□
0.37	1385	12.2	295	D11	112	113.6	450	1.53	MB/EC	K304□□-D11-D□□□-□□071□4A37AL□-D□□□□-0□□□
0.37	1385	11.1	324	D13	125	124.6	450	1.39	MB/EC	K304□□-D13-D□□□-□□071□4A37AL□-D□□□□-0□□□

马达 额定功率	马达 额定转速	减速机实际 输出转速	减速机实际 输出扭矩	减速机公称 减速比代号	减速机公称 减速比	减速机精确 减速比	减速机额定 输出扭矩	服务系数	通讯方式	订货号
Motor Rated Power	Motor Rated Speed	Actual Output Speed of Gearmotor	Actual Output Torque of Gearmotor	Nominal Ratio Code of Gearmotor	Nominal Ratio of Gearmotor	Exact Ratio of Gearmotor	Normal Output Torque of Gearmotor	Service Coefficient	Communication Mode	Order Code
P_{IN} (kw)	n_{1N} (r/min)	n_{2N} (r/min)	T_2 (N.m)	Code	i_N	i_{ex}	T_{2N} (N.m)	f		
0.55	1430	362	15	B40	4	3.95	150	10	MB/EC	K303□□-B40-D□□□-□□080□4A55AL□-D□□□□-0□□
0.55	1430	321	17	B45	4.5	4.46	150	8.82	MB/EC	K303□□-B45-D□□□-□□080□4A55AL□-D□□□□-0□□
0.55	1430	281	19	B50	5	5.08	150	7.89	MB/EC	K303□□-B50-D□□□-□□080□4A55AL□-D□□□□-0□□
0.55	1430	249	21	B56	5.6	5.74	160	7.62	MB/EC	K303□□-B56-D□□□-□□080□4A55AL□-D□□□□-0□□
0.55	1430	223	24	B63	6.3	6.42	180	7.5	MB/EC	K303□□-B63-D□□□-□□080□4A55AL□-D□□□□-0□□
0.55	1430	198	27	B71	7.1	7.24	180	6.67	MB/EC	K303□□-B71-D□□□-□□080□4A55AL□-D□□□□-0□□
0.55	1430	173	31	B80	8	8.25	180	5.81	MB/EC	K303□□-B80-D□□□-□□080□4A55AL□-D□□□□-0□□
0.55	1430	153	35	B90	9	9.33	180	5.14	MB/EC	K303□□-B90-D□□□-□□080□4A55AL□-D□□□□-0□□
0.55	1430	135	39	C10	10	10.6	180	4.62	MB/EC	K303□□-C10-D□□□-□□080□4A55AL□-D□□□□-0□□
0.55	1430	125	42	C11	11.2	11.4	180	4.29	MB/EC	K303□□-C11-D□□□-□□080□4A55AL□-D□□□□-0□□
0.55	1430	113	47	C13	12.5	12.7	180	3.83	MB/EC	K303□□-C13-D□□□-□□080□4A55AL□-D□□□□-0□□
0.55	1430	100	53	C14	14	14.3	200	3.77	MB/EC	K303□□-C14-D□□□-□□080□4A55AL□-D□□□□-0□□
0.55	1430	87.7	60	C16	16	16.3	200	3.33	MB/EC	K303□□-C16-D□□□-□□080□4A55AL□-D□□□□-0□□
0.55	1430	77.7	68	C18	18	18.4	210	3.09	MB/EC	K303□□-C18-D□□□-□□080□4A55AL□-D□□□□-0□□
0.55	1430	68.8	77	C20	20	20.8	220	2.86	MB/EC	K303□□-C20-D□□□-□□080□4A55AL□-D□□□□-0□□
0.55	1430	63.8	83	C22	22.4	22.4	225	2.71	MB/EC	K303□□-C22-D□□□-□□080□4A55AL□-D□□□□-0□□
0.55	1430	55.9	95	C25	25	25.6	230	2.42	MB/EC	K303□□-C25-D□□□-□□080□4A55AL□-D□□□□-0□□
0.55	1430	51.8	102	C28	28	27.6	230	2.25	MB/EC	K303□□-C28-D□□□-□□080□4A55AL□-D□□□□-0□□
0.55	1430	44.4	119	C32	31.5	32.2	230	1.93	MB/EC	K303□□-C32-D□□□-□□080□4A55AL□-D□□□□-0□□
0.55	1430	39.4	134	C36	35.5	36.3	230	1.72	MB/EC	K303□□-C36-D□□□-□□080□4A55AL□-D□□□□-0□□
0.55	1430	34.6	153	C40	40	41.3	230	1.5	MB/EC	K303□□-C40-D□□□-□□080□4A55AL□-D□□□□-0□□
0.55	1430	30.6	173	C45	45	46.7	230	1.33	MB/EC	K303□□-C45-D□□□-□□080□4A55AL□-D□□□□-0□□
0.55	1430	27	196	C50	50	52.9	230	1.17	MB/EC	K303□□-C50-D□□□-□□080□4A55AL□-D□□□□-0□□
0.55	1430	25.1	211	C56	56	57	230	1.09	MB/EC	K303□□-C56-D□□□-□□080□4A55AL□-D□□□□-0□□
0.55	1430	21.4	247	C63	63	66.7	230	0.93	MB/EC	K303□□-C63-D□□□-□□080□4A55AL□-D□□□□-0□□
0.55	1430	18.9	280	C71	71	75.6	230	0.82	MB/EC	K303□□-C71-D□□□-□□080□4A55AL□-D□□□□-0□□
0.55	1430	21.7	244	C63	63	66.0	450	1.84	MB/EC	K304□□-C63-D□□□-□□080□4A55AL□-D□□□□-0□□
0.55	1430	19.2	275	C71	71	74.4	450	1.64	MB/EC	K304□□-C71-D□□□-□□080□4A55AL□-D□□□□-0□□
0.55	1430	18	294	C80	80	79.5	450	1.53	MB/EC	K304□□-C80-D□□□-□□080□4A55AL□-D□□□□-0□□
0.55	1430	15.5	342	C90	90	92.4	450	1.32	MB/EC	K304□□-C90-D□□□-□□080□4A55AL□-D□□□□-0□□
0.55	1430	13.8	385	D10	100	104.0	450	1.17	MB/EC	K304□□-D10-D□□□-□□080□4A55AL□-D□□□□-0□□
0.55	1430	12.6	420	D11	112	113.6	450	1.07	MB/EC	K304□□-D11-D□□□-□□080□4A55AL□-D□□□□-0□□
0.55	1430	11.5	461	D13	125	124.6	450	0.98	MB/EC	K304□□-D13-D□□□-□□080□4A55AL□-D□□□□-0□□
0.55	1430	15.9	333	C90	90	89.9	520	1.56	MB/EC	K305□□-C90-D□□□-□□080□4A55AL□-D□□□□-0□□
0.55	1430	14.5	365	D10	100	98.6	520	1.42	MB/EC	K305□□-D10-D□□□-□□080□4A55AL□-D□□□□-0□□
0.55	1430	13.4	396	D11	112	107.1	520	1.31	MB/EC	K305□□-D11-D□□□-□□080□4A55AL□-D□□□□-0□□

马达 额定功率	马达 额定转速	减速机实际 输出转速	减速机实际 输出扭矩	减速机公称 减速比代号	减速机公称 减速比	减速机精确 减速比	减速机额定 输出扭矩	服务系数	通讯方式	订货号
Motor Rated Power	Motor Rated Speed	Actual Output Speed of Gearmotor	Actual Output Torque of Gearmotor	Nominal Ratio Code of Gearmotor	Nominal Ratio of Gearmotor	Exact Ratio of Gearmotor	Normal Output Torque of Gearmotor	Service Coefficient	Communication Mode	Order Code
P _{IN} (kw)	n _{IN} (r/min)	n _{2N} (r/min)	T ₂ (N.m)	Code	i _N	i _{ex}	T _{2N} (N.m)	f		
0.75	1430	362	20	B40	4	3.95	150	7.5	MB/EC	K303□□-B40-D□□□-□□080□4A75AL□-D□□□□-0□□
0.75	1430	321	22	B45	4.5	4.46	150	6.82	MB/EC	K303□□-B45-D□□□-□□080□4A75AL□-D□□□□-0□□
0.75	1430	281	25	B50	5	5.08	150	6	MB/EC	K303□□-B50-D□□□-□□080□4A75AL□-D□□□□-0□□
0.75	1430	249	29	B56	5.6	5.74	160	5.52	MB/EC	K303□□-B56-D□□□-□□080□4A75AL□-D□□□□-0□□
0.75	1430	223	32	B63	6.3	6.42	180	5.63	MB/EC	K303□□-B63-D□□□-□□080□4A75AL□-D□□□□-0□□
0.75	1430	198	36	B71	7.1	7.24	180	5	MB/EC	K303□□-B71-D□□□-□□080□4A75AL□-D□□□□-0□□
0.75	1430	173	41	B80	8	8.25	180	4.39	MB/EC	K303□□-B80-D□□□-□□080□4A75AL□-D□□□□-0□□
0.75	1430	153	47	B90	9	9.33	180	3.83	MB/EC	K303□□-B90-D□□□-□□080□4A75AL□-D□□□□-0□□
0.75	1430	135	53	C10	10	10.6	180	3.4	MB/EC	K303□□-C10-D□□□-□□080□4A75AL□-D□□□□-0□□
0.75	1430	125	57	C11	11.2	11.4	180	3.16	MB/EC	K303□□-C11-D□□□-□□080□4A75AL□-D□□□□-0□□
0.75	1430	113	64	C13	12.5	12.7	180	2.81	MB/EC	K303□□-C13-D□□□-□□080□4A75AL□-D□□□□-0□□
0.75	1430	100	72	C14	14	14.3	200	2.78	MB/EC	K303□□-C14-D□□□-□□080□4A75AL□-D□□□□-0□□
0.75	1430	87.7	82	C16	16	16.3	200	2.44	MB/EC	K303□□-C16-D□□□-□□080□4A75AL□-D□□□□-0□□
0.75	1430	77.7	92	C18	18	18.4	210	2.28	MB/EC	K303□□-C18-D□□□-□□080□4A75AL□-D□□□□-0□□
0.75	1430	68.8	104	C20	20	20.8	220	2.12	MB/EC	K303□□-C20-D□□□-□□080□4A75AL□-D□□□□-0□□
0.75	1430	63.8	112	C22	22.4	22.4	225	2.01	MB/EC	K303□□-C22-D□□□-□□080□4A75AL□-D□□□□-0□□
0.75	1430	55.9	128	C25	25	25.6	230	1.8	MB/EC	K303□□-C25-D□□□-□□080□4A75AL□-D□□□□-0□□
0.75	1430	51.8	138	C28	28	27.6	230	1.67	MB/EC	K303□□-C28-D□□□-□□080□4A75AL□-D□□□□-0□□
0.75	1430	44.4	161	C32	31.5	32.2	230	1.43	MB/EC	K303□□-C32-D□□□-□□080□4A75AL□-D□□□□-0□□
0.75	1430	39.4	182	C36	35.5	36.3	230	1.26	MB/EC	K303□□-C36-D□□□-□□080□4A75AL□-D□□□□-0□□
0.75	1430	34.6	207	C40	40	41.3	230	1.11	MB/EC	K303□□-C40-D□□□-□□080□4A75AL□-D□□□□-0□□
0.75	1430	30.6	234	C45	45	46.7	230	0.98	MB/EC	K303□□-C45-D□□□-□□080□4A75AL□-D□□□□-0□□
0.75	1430	27	265	C50	50	52.9	230	0.87	MB/EC	K303□□-C50-D□□□-□□080□4A75AL□-D□□□□-0□□
0.75	1430	25.1	285	C56	56	57	230	0.81	MB/EC	K303□□-C56-D□□□-□□080□4A75AL□-D□□□□-0□□
0.75	1430	30.3	236	C45	45	47.2	450	1.91	MB/EC	K304□□-C45-D□□□-□□080□4A75AL□-D□□□□-0□□
0.75	1430	27.3	262	C50	50	52.4	450	1.72	MB/EC	K304□□-C50-D□□□-□□080□4A75AL□-D□□□□-0□□
0.75	1430	23.8	301	C56	56	60.1	450	1.5	MB/EC	K304□□-C56-D□□□-□□080□4A75AL□-D□□□□-0□□
0.75	1430	21.7	330	C63	63	66.0	450	1.36	MB/EC	K304□□-C63-D□□□-□□080□4A75AL□-D□□□□-0□□
0.75	1430	19.2	372	C71	71	74.4	450	1.21	MB/EC	K304□□-C71-D□□□-□□080□4A75AL□-D□□□□-0□□
0.75	1430	18	398	C80	80	79.5	450	1.13	MB/EC	K304□□-C80-D□□□-□□080□4A75AL□-D□□□□-0□□
0.75	1430	15.5	462	C90	90	92.4	450	0.97	MB/EC	K304□□-C90-D□□□-□□080□4A75AL□-D□□□□-0□□
0.75	1430	13.8	520	D10	100	104.0	450	0.87	MB/EC	K304□□-D10-D□□□-□□080□4A75AL□-D□□□□-0□□
0.75	1430	22.7	315	C63	63	62.9	630	2	MB/EC	K305□□-C63-D□□□-□□080□4A75AL□-D□□□□-0□□
0.75	1430	19.5	366	C71	71	73.2	520	1.42	MB/EC	K305□□-C71-D□□□-□□080□4A75AL□-D□□□□-0□□
0.75	1430	17.4	412	C80	80	82.3	520	1.26	MB/EC	K305□□-C80-D□□□-□□080□4A75AL□-D□□□□-0□□
0.75	1430	15.9	450	C90	90	89.9	520	1.16	MB/EC	K305□□-C90-D□□□-□□080□4A75AL□-D□□□□-0□□
0.75	1430	14.5	493	D10	100	98.6	520	1.05	MB/EC	K305□□-D10-D□□□-□□080□4A75AL□-D□□□□-0□□
0.75	1430	13.4	536	D11	112	107.1	520	0.97	MB/EC	K305□□-D11-D□□□-□□080□4A75AL□-D□□□□-0□□
0.75	1430	14.8	484	D10	100	96.7	850	1.76	MB/EC	K306□□-D10-D□□□-□□080□4A75AL□-D□□□□-0□□
0.75	1430	12.4	575	D11	112	115.0	850	1.48	MB/EC	K306□□-D11-D□□□-□□080□4A75AL□-D□□□□-0□□
0.75	1430	11.7	612	D13	125	122.3	850	1.39	MB/EC	K306□□-D13-D□□□-□□080□4A75AL□-D□□□□-0□□

马达 额定功率	马达 额定转速	减速机实际 输出转速	减速机实际 输出扭矩	减速机公称 减速比代号	减速机公称 减速比	减速机精确 减速比	减速机额定 输出扭矩	服务系数	通讯方式	订货号
Motor Rated Power	Motor Rated Speed	Actual Output Speed of Gearmotor	Actual Output Torque of Gearmotor	Nominal Ratio Code of Gearmotor	Nominal Ratio of Gearmotor	Exact Ratio of Gearmotor	Normal Output Torque of Gearmotor	Service Coefficient	Communication Mode	Order Code
P_{1N} (kw)	n_{1N} (r/min)	n_{2N} (r/min)	T_2 (N.m)	Code	i_N	i_{ex}	T_{2N} (N.m)	f		
1.1	1435	363	29	B40	4	3.95	150	5.17	MB/EC	K303□□-B40-D□□□-□□090□4B11AL□-D□□□□-0□□
1.1	1435	322	33	B45	4.5	4.46	150	4.55	MB/EC	K303□□-B45-D□□□-□□090□4B11AL□-D□□□□-0□□
1.1	1435	282	37	B50	5	5.08	150	4.05	MB/EC	K303□□-B50-D□□□-□□090□4B11AL□-D□□□□-0□□
1.1	1435	250	42	B56	5.6	5.74	160	3.81	MB/EC	K303□□-B56-D□□□-□□090□4B11AL□-D□□□□-0□□
1.1	1435	224	47	B63	6.3	6.42	180	3.83	MB/EC	K303□□-B63-D□□□-□□090□4B11AL□-D□□□□-0□□
1.1	1435	198	53	B71	7.1	7.24	180	3.4	MB/EC	K303□□-B71-D□□□-□□090□4B11AL□-D□□□□-0□□
1.1	1435	174	60	B80	8	8.25	180	3	MB/EC	K303□□-B80-D□□□-□□090□4B11AL□-D□□□□-0□□
1.1	1435	154	68	B90	9	9.33	180	2.65	MB/EC	K303□□-B90-D□□□-□□090□4B11AL□-D□□□□-0□□
1.1	1435	135	77	C10	10	10.6	180	2.34	MB/EC	K303□□-C10-D□□□-□□090□4B11AL□-D□□□□-0□□
1.1	1435	126	83	C11	11.2	11.4	180	2.17	MB/EC	K303□□-C11-D□□□-□□090□4B11AL□-D□□□□-0□□
1.1	1435	113	93	C13	12.5	12.7	180	1.94	MB/EC	K303□□-C13-D□□□-□□090□4B11AL□-D□□□□-0□□
1.1	1435	100	104	C14	14	14.3	200	1.92	MB/EC	K303□□-C14-D□□□-□□090□4B11AL□-D□□□□-0□□
1.1	1435	88	119	C16	16	16.3	200	1.68	MB/EC	K303□□-C16-D□□□-□□090□4B11AL□-D□□□□-0□□
1.1	1435	78	134	C18	18	18.4	210	1.57	MB/EC	K303□□-C18-D□□□-□□090□4B11AL□-D□□□□-0□□
1.1	1435	69	152	C20	20	20.8	220	1.45	MB/EC	K303□□-C20-D□□□-□□090□4B11AL□-D□□□□-0□□
1.1	1435	64.1	164	C22	22.4	22.4	225	1.37	MB/EC	K303□□-C22-D□□□-□□090□4B11AL□-D□□□□-0□□
1.1	1435	56.1	187	C25	25	25.6	230	1.23	MB/EC	K303□□-C25-D□□□-□□090□4B11AL□-D□□□□-0□□
1.1	1435	52	201	C28	28	27.6	230	1.14	MB/EC	K303□□-C28-D□□□-□□090□4B11AL□-D□□□□-0□□
1.1	1435	44.6	235	C32	31.5	32.2	230	0.98	MB/EC	K303□□-C32-D□□□-□□090□4B11AL□-D□□□□-0□□
1.1	1435	39.5	265	C36	35.5	36.3	230	0.87	MB/EC	K303□□-C36-D□□□-□□090□4B11AL□-D□□□□-0□□
1.1	1435	45.6	230	C32	31.5	31.5	450	1.96	MB/EC	K304□□-C32-D□□□-□□090□4B11AL□-D□□□□-0□□
1.1	1435	38.6	272	C36	35.5	37.2	450	1.65	MB/EC	K304□□-C36-D□□□-□□090□4B11AL□-D□□□□-0□□
1.1	1435	34.3	305	C40	40	41.8	450	1.48	MB/EC	K304□□-C40-D□□□-□□090□4B11AL□-D□□□□-0□□
1.1	1435	30.4	345	C45	45	47.2	450	1.3	MB/EC	K304□□-C45-D□□□-□□090□4B11AL□-D□□□□-0□□
1.1	1435	27.4	383	C50	50	52.4	450	1.17	MB/EC	K304□□-C50-D□□□-□□090□4B11AL□-D□□□□-0□□
1.1	1435	23.9	439	C56	56	60.1	450	1.03	MB/EC	K304□□-C56-D□□□-□□090□4B11AL□-D□□□□-0□□
1.1	1435	21.7	482	C63	63	66.0	450	0.93	MB/EC	K304□□-C63-D□□□-□□090□4B11AL□-D□□□□-0□□
1.1	1435	19.3	543	C71	71	74.4	450	0.83	MB/EC	K304□□-C71-D□□□-□□090□4B11AL□-D□□□□-0□□
1.1	1435	27.4	382	C50	50	52.3	680	1.78	MB/EC	K305□□-C50-D□□□-□□090□4B11AL□-D□□□□-0□□
1.1	1435	24.4	430	C56	56	58.9	680	1.58	MB/EC	K305□□-C56-D□□□-□□090□4B11AL□-D□□□□-0□□
1.1	1435	22.8	459	C63	63	62.9	630	1.37	MB/EC	K305□□-C63-D□□□-□□090□4B11AL□-D□□□□-0□□
1.1	1435	22.7	462	C63	63	63.3	950	2.06	MB/EC	K306□□-C63-D□□□-□□090□4B11AL□-D□□□□-0□□
1.1	1435	20.8	504	C71	71	69.1	950	1.88	MB/EC	K306□□-C71-D□□□-□□090□4B11AL□-D□□□□-0□□
1.1	1435	18.2	575	C80	80	78.7	950	1.65	MB/EC	K306□□-C80-D□□□-□□090□4B11AL□-D□□□□-0□□
1.1	1435	17.2	610	C90	90	83.6	900	1.48	MB/EC	K306□□-C90-D□□□-□□090□4B11AL□-D□□□□-0□□

马达 额定功率	马达 额定转速	减速机实际 输出转速	减速机实际 输出扭矩	减速机公称 减速比代号	减速机公称 减速比	减速机精确 减速比	减速机额定 输出扭矩	服务系数	通讯方式	订货号
Motor Rated Power	Motor Rated Speed	Actual Output Speed of Gearmotor	Actual Output Torque of Gearmotor	Nominal Ratio Code of Gearmotor	Nominal Ratio of Gearmotor	Exact Ratio of Gearmotor	Normal Output Torque of Gearmotor	Service Coefficient	Communication Mode	Order Code
P _{1N} (kw)	n _{1N} (r/min)	n _{2N} (r/min)	T ₂ (N.m)	Code	i _N	i _{ex}	T _{2N} (N.m)	f		
1.5	1435	363	40	B40	4	3.95	150	3.75	MB/EC	K303□□-B40-D□□□-□□090□4B15AL□-D□□□□-0□□
1.5	1435	322	45	B45	4.5	4.46	150	3.33	MB/EC	K303□□-B45-D□□□-□□090□4B15AL□-D□□□□-0□□
1.5	1435	282	51	B50	5	5.08	150	2.94	MB/EC	K303□□-B50-D□□□-□□090□4B15AL□-D□□□□-0□□
1.5	1435	250	57	B56	5.6	5.74	160	2.81	MB/EC	K303□□-B56-D□□□-□□090□4B15AL□-D□□□□-0□□
1.5	1435	224	64	B63	6.3	6.42	180	2.81	MB/EC	K303□□-B63-D□□□-□□090□4B15AL□-D□□□□-0□□
1.5	1435	198	72	B71	7.1	7.24	180	2.5	MB/EC	K303□□-B71-D□□□-□□090□4B15AL□-D□□□□-0□□
1.5	1435	174	83	B80	8	8.25	180	2.17	MB/EC	K303□□-B80-D□□□-□□090□4B15AL□-D□□□□-0□□
1.5	1435	154	93	B90	9	9.33	180	1.94	MB/EC	K303□□-B90-D□□□-□□090□4B15AL□-D□□□□-0□□
1.5	1435	135	106	C10	10	10.6	180	1.7	MB/EC	K303□□-C10-D□□□-□□090□4B15AL□-D□□□□-0□□
1.5	1435	126	114	C11	11.2	11.4	180	1.58	MB/EC	K303□□-C11-D□□□-□□090□4B15AL□-D□□□□-0□□
1.5	1435	113	127	C13	12.5	12.7	180	1.42	MB/EC	K303□□-C13-D□□□-□□090□4B15AL□-D□□□□-0□□
1.5	1435	100	143	C14	14	14.3	200	1.4	MB/EC	K303□□-C14-D□□□-□□090□4B15AL□-D□□□□-0□□
1.5	1435	88	163	C16	16	16.3	200	1.23	MB/EC	K303□□-C16-D□□□-□□090□4B15AL□-D□□□□-0□□
1.5	1435	78	184	C18	18	18.4	210	1.14	MB/EC	K303□□-C18-D□□□-□□090□4B15AL□-D□□□□-0□□
1.5	1435	69	208	C20	20	20.8	220	1.06	MB/EC	K303□□-C20-D□□□-□□090□4B15AL□-D□□□□-0□□
1.5	1435	64.1	224	C22	22.4	22.4	225	1	MB/EC	K303□□-C22-D□□□-□□090□4B15AL□-D□□□□-0□□
1.5	1435	56.1	256	C25	25	25.6	230	0.9	MB/EC	K303□□-C25-D□□□-□□090□4B15AL□-D□□□□-0□□
1.5	1435	52	276	C28	28	27.6	230	0.83	MB/EC	K303□□-C28-D□□□-□□090□4B15AL□-D□□□□-0□□
1.5	1435	59.8	240	C25	25	24.0	450	1.88	MB/EC	K304□□-C25-D□□□-□□090□4B15AL□-D□□□□-0□□
1.5	1435	53	271	C28	28	27.1	450	1.66	MB/EC	K304□□-C28-D□□□-□□090□4B15AL□-D□□□□-0□□
1.5	1435	45.6	315	C32	31.5	31.5	450	1.43	MB/EC	K304□□-C32-D□□□-□□090□4B15AL□-D□□□□-0□□
1.5	1435	38.6	372	C36	35.5	37.2	450	1.21	MB/EC	K304□□-C36-D□□□-□□090□4B15AL□-D□□□□-0□□
1.5	1435	34.3	418	C40	40	41.8	450	1.08	MB/EC	K304□□-C40-D□□□-□□090□4B15AL□-D□□□□-0□□
1.5	1435	30.4	472	C45	45	47.2	450	0.95	MB/EC	K304□□-C45-D□□□-□□090□4B15AL□-D□□□□-0□□
1.5	1435	27.4	524	C50	50	52.4	450	0.86	MB/EC	K304□□-C50-D□□□-□□090□4B15AL□-D□□□□-0□□
1.5	1435	34.6	415	C40	40	41.5	680	1.64	MB/EC	K305□□-C40-D□□□-□□090□4B15AL□-D□□□□-0□□
1.5	1435	30.2	475	C45	45	47.5	680	1.43	MB/EC	K305□□-C45-D□□□-□□090□4B15AL□-D□□□□-0□□
1.5	1435	27.4	523	C50	50	52.3	680	1.3	MB/EC	K305□□-C50-D□□□-□□090□4B15AL□-D□□□□-0□□
1.5	1435	24.4	589	C56	56	58.9	680	1.15	MB/EC	K305□□-C56-D□□□-□□090□4B15AL□-D□□□□-0□□
1.5	1435	22.8	629	C63	63	62.9	630	1	MB/EC	K305□□-C63-D□□□-□□090□4B15AL□-D□□□□-0□□
1.5	1435	25.8	557	C56	56	55.7	950	1.71	MB/EC	K306□□-C56-D□□□-□□090□4B15AL□-D□□□□-0□□
1.5	1435	22.7	633	C63	63	63.3	950	1.5	MB/EC	K306□□-C63-D□□□-□□090□4B15AL□-D□□□□-0□□
1.5	1435	20.8	691	C71	71	69.1	950	1.37	MB/EC	K306□□-C71-D□□□-□□090□4B15AL□-D□□□□-0□□
1.5	1435	18.2	787	C80	80	78.7	950	1.21	MB/EC	K306□□-C80-D□□□-□□090□4B15AL□-D□□□□-0□□
1.5	1435	17.2	836	C90	90	83.6	900	1.08	MB/EC	K306□□-C90-D□□□-□□090□4B15AL□-D□□□□-0□□
1.5	1435	17	842	C90	90	84.2	1750	2.08	MB/EC	K307□□-C90-D□□□-□□090□4B15AL□-D□□□□-0□□
1.5	1435	15.5	923	D10	100	92.3	1750	1.9	MB/EC	K307□□-D10-D□□□-□□090□4B15AL□-D□□□□-0□□
1.5	1435	13.3	1083	D11	112	108.3	1750	1.62	MB/EC	K307□□-D11-D□□□-□□090□4B15AL□-D□□□□-0□□

马达 额定功率	马达 额定转速	减速机实际 输出转速	减速机实际 输出扭矩	减速机公称 减速比代号	减速机公称 减速比	减速机精确 减速比	减速机额定 输出扭矩	服务系数	通讯方式	订货号
Motor Rated Power	Motor Rated Speed	Actual Output Speed of Gearmotor	Actual Output Torque of Gearmotor	Nominal Ratio Code of Gearmotor	Nominal Ratio of Gearmotor	Exact Ratio of Gearmotor	Normal Output Torque of Gearmotor	Service Coefficient	Communication Mode	Order Code
P _{1N} (kw)	n _{1N} (r/min)	n _{2N} (r/min)	T ₂ (N.m)	Code	i _N	i _{ex}	T _{2N} (N.m)	f		
2.2	1455	368	57	B40	4	3.95	150	2.63	MB/EC	K303□□-B40-D□□□-□□100□4B22AL□-D□□□□-0□□
2.2	1455	326	64	B45	4.5	4.46	150	2.34	MB/EC	K303□□-B45-D□□□-□□100□4B22AL□-D□□□□-0□□
2.2	1455	286	73	B50	5	5.08	150	2.05	MB/EC	K303□□-B50-D□□□-□□100□4B22AL□-D□□□□-0□□
2.2	1455	253	83	B56	5.6	5.74	160	1.93	MB/EC	K303□□-B56-D□□□-□□100□4B22AL□-D□□□□-0□□
2.2	1455	227	92	B63	6.3	6.42	180	1.96	MB/EC	K303□□-B63-D□□□-□□100□4B22AL□-D□□□□-0□□
2.2	1455	201	104	B71	7.1	7.24	180	1.73	MB/EC	K303□□-B71-D□□□-□□100□4B22AL□-D□□□□-0□□
2.2	1455	176	119	B80	8	8.25	180	1.51	MB/EC	K303□□-B80-D□□□-□□100□4B22AL□-D□□□□-0□□
2.2	1455	156	134	B90	9	9.33	180	1.34	MB/EC	K303□□-B90-D□□□-□□100□4B22AL□-D□□□□-0□□
2.2	1455	137	153	C10	10	10.6	180	1.18	MB/EC	K303□□-C10-D□□□-□□100□4B22AL□-D□□□□-0□□
2.2	1455	128	164	C11	11.2	11.4	180	1.1	MB/EC	K303□□-C11-D□□□-□□100□4B22AL□-D□□□□-0□□
2.2	1455	115	183	C13	12.5	12.7	180	0.98	MB/EC	K303□□-C13-D□□□-□□100□4B22AL□-D□□□□-0□□
2.2	1455	102	206	C14	14	14.3	200	0.97	MB/EC	K303□□-C14-D□□□-□□100□4B22AL□-D□□□□-0□□
2.2	1455	89.3	235	C16	16	16.3	200	0.85	MB/EC	K303□□-C16-D□□□-□□100□4B22AL□-D□□□□-0□□
2.2	1455	117	179	C13	12.5	12.4	380	2.12	MB/EC	K304□□-C13-D□□□-□□100□4B22AL□-D□□□□-0□□
2.2	1455	108	194	C14	14	13.5	400	2.06	MB/EC	K304□□-C14-D□□□-□□100□4B22AL□-D□□□□-0□□
2.2	1455	95.7	219	C16	16	15.2	420	1.92	MB/EC	K304□□-C16-D□□□-□□100□4B22AL□-D□□□□-0□□
2.2	1455	84.6	248	C18	18	17.2	420	1.69	MB/EC	K304□□-C18-D□□□-□□100□4B22AL□-D□□□□-0□□
2.2	1455	76.2	275	C20	20	19.1	450	1.64	MB/EC	K304□□-C20-D□□□-□□100□4B22AL□-D□□□□-0□□
2.2	1455	66.7	314	C22	22.4	21.8	450	1.43	MB/EC	K304□□-C22-D□□□-□□100□4B22AL□-D□□□□-0□□
2.2	1455	60.6	346	C25	25	24.0	450	1.3	MB/EC	K304□□-C25-D□□□-□□100□4B22AL□-D□□□□-0□□
2.2	1455	53.7	390	C28	28	27.1	450	1.15	MB/EC	K304□□-C28-D□□□-□□100□4B22AL□-D□□□□-0□□
2.2	1455	46.2	454	C32	31.5	31.5	450	0.99	MB/EC	K304□□-C32-D□□□-□□100□4B22AL□-D□□□□-0□□
2.2	1455	39.1	536	C36	35.5	37.2	450	0.84	MB/EC	K304□□-C36-D□□□-□□100□4B22AL□-D□□□□-0□□
2.2	1455	49.3	425	C28	28	29.5	680	1.6	MB/EC	K305□□-C28-D□□□-□□100□4B22AL□-D□□□□-0□□
2.2	1455	44	477	C32	31.5	33.1	680	1.43	MB/EC	K305□□-C32-D□□□-□□100□4B22AL□-D□□□□-0□□
2.2	1455	38.9	539	C36	35.5	37.4	680	1.26	MB/EC	K305□□-C36-D□□□-□□100□4B22AL□-D□□□□-0□□
2.2	1455	35.1	598	C40	40	41.5	680	1.14	MB/EC	K305□□-C40-D□□□-□□100□4B22AL□-D□□□□-0□□
2.2	1455	30.6	684	C45	45	47.5	680	0.99	MB/EC	K305□□-C45-D□□□-□□100□4B22AL□-D□□□□-0□□
2.2	1455	27.8	753	C50	50	52.3	680	0.9	MB/EC	K305□□-C50-D□□□-□□100□4B22AL□-D□□□□-0□□
2.2	1455	24.7	848	C56	56	58.9	680	0.8	MB/EC	K305□□-C56-D□□□-□□100□4B22AL□-D□□□□-0□□
2.2	1455	38.1	550	C40	40	38.2	950	1.73	MB/EC	K306□□-C40-D□□□-□□100□4B22AL□-D□□□□-0□□
2.2	1455	32	655	C45	45	45.5	950	1.45	MB/EC	K306□□-C45-D□□□-□□100□4B22AL□-D□□□□-0□□
2.2	1455	28.7	730	C50	50	50.7	950	1.3	MB/EC	K306□□-C50-D□□□-□□100□4B22AL□-D□□□□-0□□
2.2	1455	26.1	802	C56	56	55.7	950	1.18	MB/EC	K306□□-C56-D□□□-□□100□4B22AL□-D□□□□-0□□
2.2	1455	23	912	C63	63	63.3	950	1.04	MB/EC	K306□□-C63-D□□□-□□100□4B22AL□-D□□□□-0□□
2.2	1455	21.1	995	C71	71	69.1	950	0.95	MB/EC	K306□□-C71-D□□□-□□100□4B22AL□-D□□□□-0□□
2.2	1455	18.5	1133	C80	80	78.7	950	0.84	MB/EC	K306□□-C80-D□□□-□□100□4B22AL□-D□□□□-0□□
2.2	1455	21.1	992	C71	71	68.9	1750	1.76	MB/EC	K307□□-C71-D□□□-□□100□4B22AL□-D□□□□-0□□
2.2	1455	19.4	1079	C80	80	74.9	1750	1.62	MB/EC	K307□□-C80-D□□□-□□100□4B22AL□-D□□□□-0□□
2.2	1455	17.3	1212	C90	90	84.2	1750	1.44	MB/EC	K307□□-C90-D□□□-□□100□4B22AL□-D□□□□-0□□
2.2	1455	15.8	1329	D10	100	92.3	1750	1.32	MB/EC	K307□□-D10-D□□□-□□100□4B22AL□-D□□□□-0□□
2.2	1455	13.4	1560	D11	112	108.3	1750	1.12	MB/EC	K307□□-D11-D□□□-□□100□4B22AL□-D□□□□-0□□
2.2	1455	12.8	1636	D11	112	113.6	3000	1.83	MB/EC	K308□□-D11-D□□□-□□100□4B22AL□-D□□□□-0□□
2.2	1455	11.4	1840	D13	125	127.8	3000	1.63	MB/EC	K308□□-D13-D□□□-□□100□4B22AL□-D□□□□-0□□
2.2	1455	10.3	2025	D14	140	140.6	3000	1.48	MB/EC	K308□□-D14-D□□□-□□100□4B22AL□-D□□□□-0□□
2.2	1455	9.5	2213	D16	160	153.7	2500	1.13	MB/EC	K308□□-D16-D□□□-□□100□4B22AL□-D□□□□-0□□

马达 额定功率	马达 额定转速	减速机实际 输出转速	减速机实际 输出扭矩	减速机公称 减速比代号	减速机公称 减速比	减速机精确 减速比	减速机额定 输出扭矩	服务系数	通讯方式	订货号
Motor Rated Power	Motor Rated Speed	Actual Output Speed of Gearmotor	Actual Output Torque of Gearmotor	Nominal Ratio Code of Gearmotor	Nominal Ratio of Gearmotor	Exact Ratio of Gearmotor	Normal Output Torque of Gearmotor	Service Coefficient	Communication Mode	Order Code
P _{IN} (kw)	n _{IN} (r/min)	n _{2N} (r/min)	T ₂ (N.m)	Code	i _N	i _{ex}	T _{2N} (N.m)	f		
3	1455	368	78	B40	4	3.95	150	1.92	MB/EC	K303□□-B40-D□□□-□□100□4B30AL□-D□□□□-0□□
3	1455	326	88	B45	4.5	4.46	150	1.7	MB/EC	K303□□-B45-D□□□-□□100□4B30AL□-D□□□□-0□□
3	1455	286	100	B50	5	5.08	150	1.5	MB/EC	K303□□-B50-D□□□-□□100□4B30AL□-D□□□□-0□□
3	1455	253	113	B56	5.6	5.74	160	1.42	MB/EC	K303□□-B56-D□□□-□□100□4B30AL□-D□□□□-0□□
3	1455	227	126	B63	6.3	6.42	180	1.43	MB/EC	K303□□-B63-D□□□-□□100□4B30AL□-D□□□□-0□□
3	1455	201	143	B71	7.1	7.24	180	1.26	MB/EC	K303□□-B71-D□□□-□□100□4B30AL□-D□□□□-0□□
3	1455	176	163	B80	8	8.25	180	1.1	MB/EC	K303□□-B80-D□□□-□□100□4B30AL□-D□□□□-0□□
3	1455	156	184	B90	9	9.33	180	0.98	MB/EC	K303□□-B90-D□□□-□□100□4B30AL□-D□□□□-0□□
3	1455	137	209	C10	10	10.6	180	0.86	MB/EC	K303□□-C10-D□□□-□□100□4B30AL□-D□□□□-0□□
3	1455	128	225	C11	11.2	11.4	180	0.8	MB/EC	K303□□-C11-D□□□-□□100□4B30AL□-D□□□□-0□□
3	1455	167	172	B90	9	8.71	310	1.8	MB/EC	K304□□-B90-D□□□-□□100□4B30AL□-D□□□□-0□□
3	1455	146	197	C10	10	9.98	340	1.73	MB/EC	K304□□-C10-D□□□-□□100□4B30AL□-D□□□□-0□□
3	1455	132	217	C11	11.2	11.0	360	1.66	MB/EC	K304□□-C11-D□□□-□□100□4B30AL□-D□□□□-0□□
3	1455	117	244	C13	12.5	12.4	380	1.56	MB/EC	K304□□-C13-D□□□-□□100□4B30AL□-D□□□□-0□□
3	1455	108	266	C14	14	13.5	400	1.5	MB/EC	K304□□-C14-D□□□-□□100□4B30AL□-D□□□□-0□□
3	1455	95.7	299	C16	16	15.2	420	1.4	MB/EC	K304□□-C16-D□□□-□□100□4B30AL□-D□□□□-0□□
3	1455	84.6	339	C18	18	17.2	420	1.24	MB/EC	K304□□-C18-D□□□-□□100□4B30AL□-D□□□□-0□□
3	1455	76.2	376	C20	20	19.1	450	1.2	MB/EC	K304□□-C20-D□□□-□□100□4B30AL□-D□□□□-0□□
3	1455	66.7	429	C22	22.4	21.8	450	1.05	MB/EC	K304□□-C22-D□□□-□□100□4B30AL□-D□□□□-0□□
3	1455	60.6	473	C25	25	24.0	450	0.95	MB/EC	K304□□-C25-D□□□-□□100□4B30AL□-D□□□□-0□□
3	1455	53.7	534	C28	28	27.1	450	0.84	MB/EC	K304□□-C28-D□□□-□□100□4B30AL□-D□□□□-0□□
3	1455	68	422	C22	22.4	21.4	680	1.61	MB/EC	K305□□-C22-D□□□-□□100□4B30AL□-D□□□□-0□□
3	1455	63.5	451	C25	25	22.9	680	1.51	MB/EC	K305□□-C25-D□□□-□□100□4B30AL□-D□□□□-0□□
3	1455	49.3	581	C28	28	29.5	680	1.17	MB/EC	K305□□-C28-D□□□-□□100□4B30AL□-D□□□□-0□□
3	1455	44	652	C32	31.5	33.1	680	1.04	MB/EC	K305□□-C32-D□□□-□□100□4B30AL□-D□□□□-0□□
3	1455	38.9	737	C36	35.5	37.4	680	0.92	MB/EC	K305□□-C36-D□□□-□□100□4B30AL□-D□□□□-0□□
3	1455	35.1	818	C40	40	41.5	680	0.83	MB/EC	K305□□-C40-D□□□-□□100□4B30AL□-D□□□□-0□□
3	1455	46.6	615	C32	31.5	31.2	950	1.54	MB/EC	K306□□-C32-D□□□-□□100□4B30AL□-D□□□□-0□□
3	1455	40.6	705	C36	35.5	35.8	950	1.35	MB/EC	K306□□-C36-D□□□-□□100□4B30AL□-D□□□□-0□□
3	1455	38.1	753	C40	40	38.2	950	1.26	MB/EC	K306□□-C40-D□□□-□□100□4B30AL□-D□□□□-0□□
3	1455	32	896	C45	45	45.5	950	1.06	MB/EC	K306□□-C45-D□□□-□□100□4B30AL□-D□□□□-0□□
3	1455	28.7	999	C50	50	50.7	950	0.95	MB/EC	K306□□-C50-D□□□-□□100□4B30AL□-D□□□□-0□□
3	1455	26.1	1097	C56	56	55.7	950	0.87	MB/EC	K306□□-C56-D□□□-□□100□4B30AL□-D□□□□-0□□
3	1455	28.8	995	C50	50	50.5	1750	1.76	MB/EC	K307□□-C50-D□□□-□□100□4B30AL□-D□□□□-0□□
3	1455	25.8	1113	C56	56	56.5	1750	1.57	MB/EC	K307□□-C56-D□□□-□□100□4B30AL□-D□□□□-0□□
3	1455	23.1	1239	C63	63	62.9	1750	1.41	MB/EC	K307□□-C63-D□□□-□□100□4B30AL□-D□□□□-0□□
3	1455	21.1	1357	C71	71	68.9	1750	1.29	MB/EC	K307□□-C71-D□□□-□□100□4B30AL□-D□□□□-0□□
3	1455	19.4	1476	C80	80	74.9	1750	1.19	MB/EC	K307□□-C80-D□□□-□□100□4B30AL□-D□□□□-0□□
3	1455	17.3	1659	C90	90	84.2	1750	1.05	MB/EC	K307□□-C90-D□□□-□□100□4B30AL□-D□□□□-0□□
3	1455	15.8	1818	D10	100	92.3	1750	0.96	MB/EC	K307□□-D10-D□□□-□□100□4B30AL□-D□□□□-0□□
3	1455	13.4	2134	D11	112	108.3	1750	0.82	MB/EC	K307□□-D11-D□□□-□□100□4B30AL□-D□□□□-0□□
3	1455	16.2	1773	C90	90	90.0	3000	1.69	MB/EC	K308□□-C90-D□□□-□□100□4B30AL□-D□□□□-0□□
3	1455	14.2	2015	D10	100	102.3	3000	1.49	MB/EC	K308□□-D10-D□□□-□□100□4B30AL□-D□□□□-0□□
3	1455	12.8	2238	D11	112	113.6	3000	1.34	MB/EC	K308□□-D11-D□□□-□□100□4B30AL□-D□□□□-0□□
3	1455	11.4	2518	D13	125	127.8	3000	1.19	MB/EC	K308□□-D13-D□□□-□□100□4B30AL□-D□□□□-0□□
3	1455	10.3	2770	D14	140	140.6	3000	1.08	MB/EC	K308□□-D14-D□□□-□□100□4B30AL□-D□□□□-0□□
3	1455	9.5	3028	D16	160	153.7	2500	0.83	MB/EC	K308□□-D16-D□□□-□□100□4B30AL□-D□□□□-0□□

6.外形尺寸图(mm)

6.Dimensions (mm)

K303

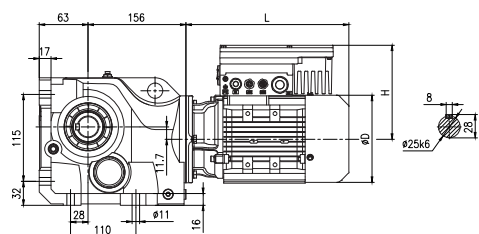

Horizontal foot-mounted H

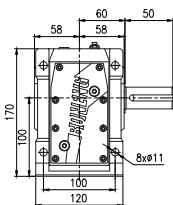

K303HA

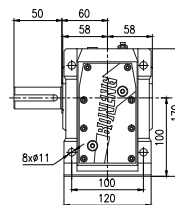

K303HB

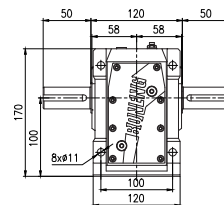

K303HC

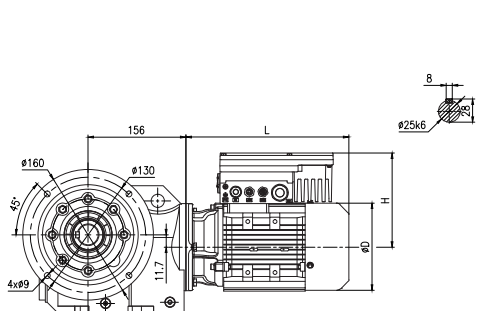

Flange-mounted F

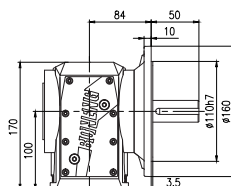

K303FA

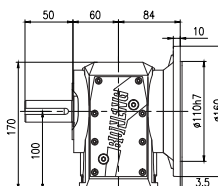

K303FB

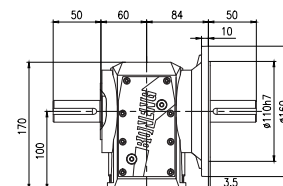

K303FC

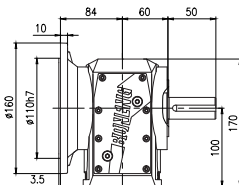

K303FD

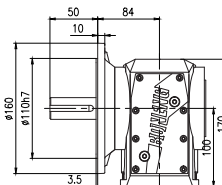

K303FE

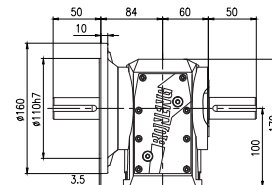

K303FF

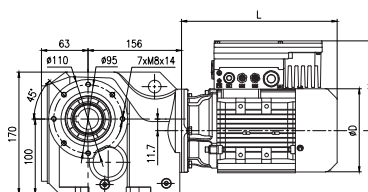

Short flange-mounted S

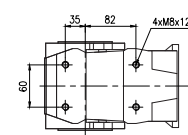

Shaft-mounted A

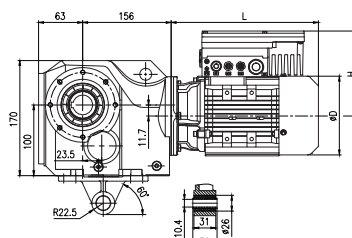

Torque arm-mounted with accessory T

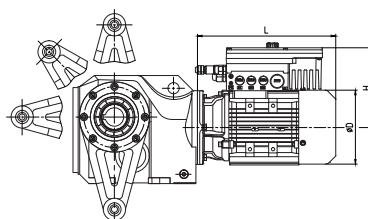

Torque arm-mounted with side accessory M

Dimension Data of Gearmotor Variable Frequency Drive
All-in-one (mm) 50Hz-1500r/min

Power of 4 pole type (kW)	Range of Ratio	MH			MP		
		L	D	H	L	D	H
0.25	4-100	223	138	151.5	223	138	151.5
0.37	4-100	223	138	151.5	223	138	151.5
0.55	4-71	299	159	173	299	159	173
0.75	4-56	299	159	173	299	159	173
1.1	4-35.5	321	176	188.5	321	176	188.5
1.5	4-28	321	176	188.5	346	176	188.5
2.2	4-16	394	198	191	394	198	191
3	4-11.2	394	198	191	394	198	191

K303

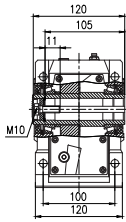

K303HG

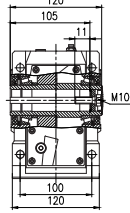

K303HH

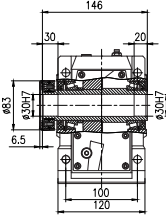

K303HI

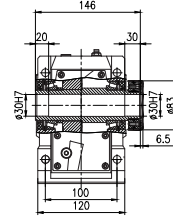

K303HJ

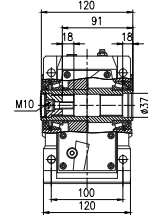

K303HK

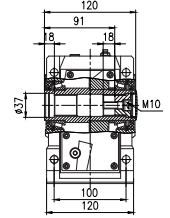

K303HL

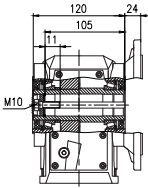

K303FG

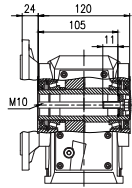

K303FH

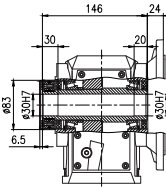

K303FI

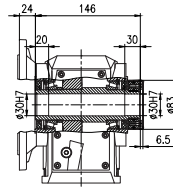

K303FJ

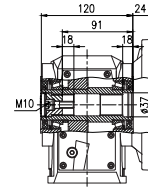

K303FK

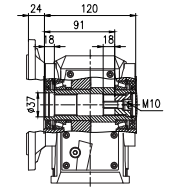

K303FL

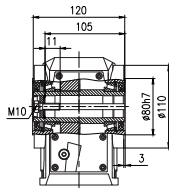

K303SG
K303AG

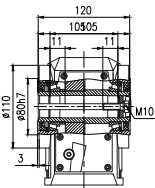

K303SH
K303AH

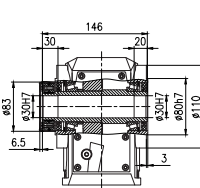

K303SI
K303AI

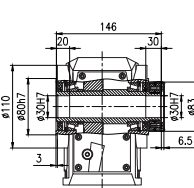

K303SJ
K303AJ

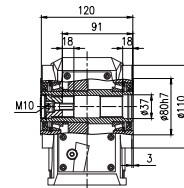

K303SK
K303AK

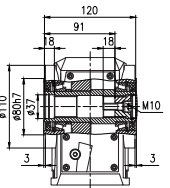

K303SL
K303AL

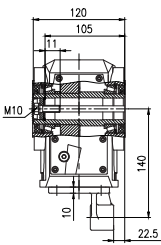

K303TG

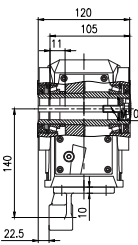

K303TH

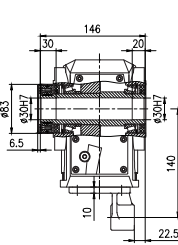

K303TI

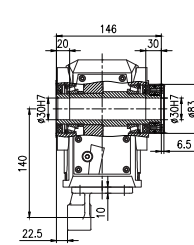

K303TJ

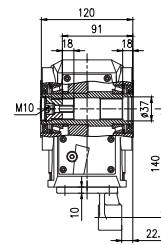

K303TK

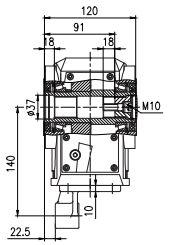

K303TL

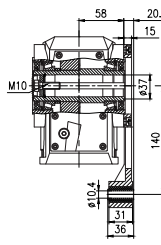

K303MG

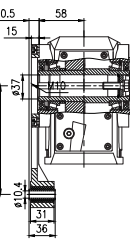

K303MH

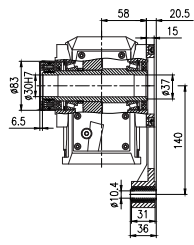

K303MI

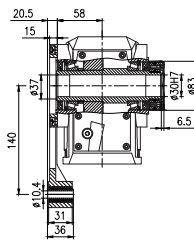

K303MJ

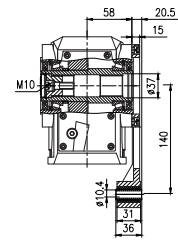

K303MK

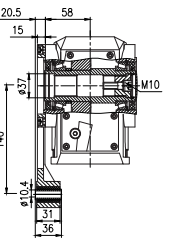

K303ML

K304

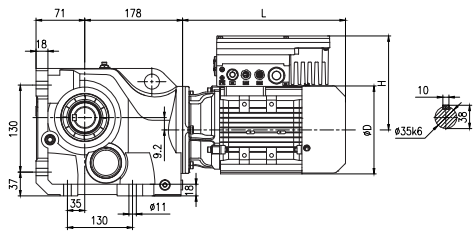

Horizontal foot-mounted H

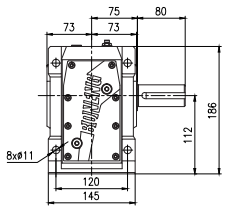

K304HA

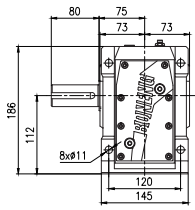

K304HB

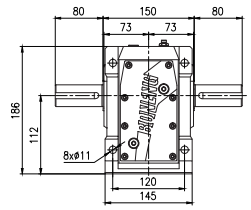

K304HC

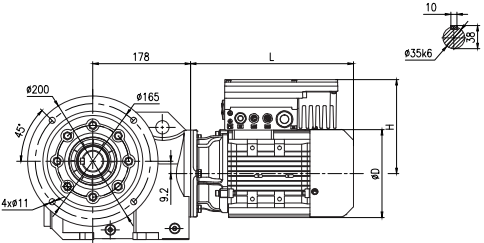

Flange-mounted F

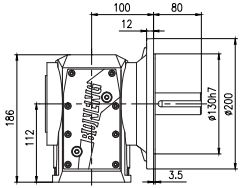

K304FA

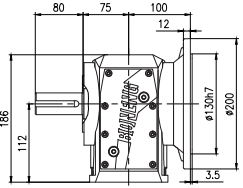

K304FB

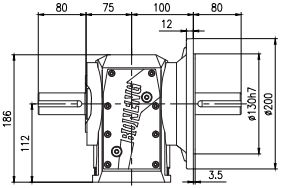

K304FC

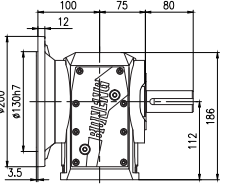

K304FD

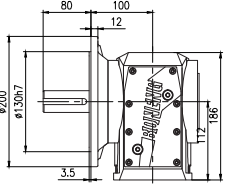

K304FE

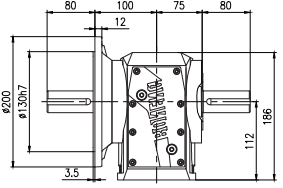

K304FF

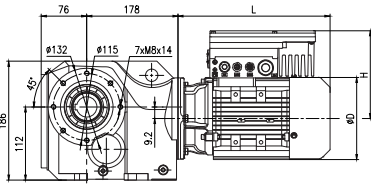

Short flange-mounted S

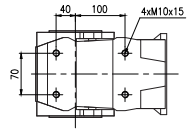

Shaft-mounted A

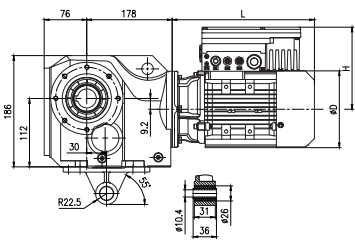

Torque arm-mounted with accessory T

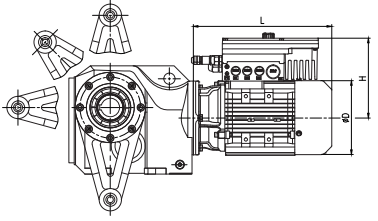

Torque arm-mounted with side accessory M

Dimension Data of Gearmotor Variable Frequency Drive All-in-one (mm) 50Hz-1500r/min								
Power of 4 pole type (kW)	Range of Ratio	MH			MP			H
		L	D	H	L	D	H	
0.37	90-125	224	138	151.5	224	138	151.5	
0.55	63-125	300	159	173	300	159	173	
0.75	45-100	300	159	173	300	159	173	
1.1	31.5-71	323	176	188.5	323	176	188.5	
1.5	25-50	323	176	188.5	348	176	188.5	
2.2	12.5-35.5	395	198	191	395	198	191	
3	9-28	395	198	191	395	198	191	

K304

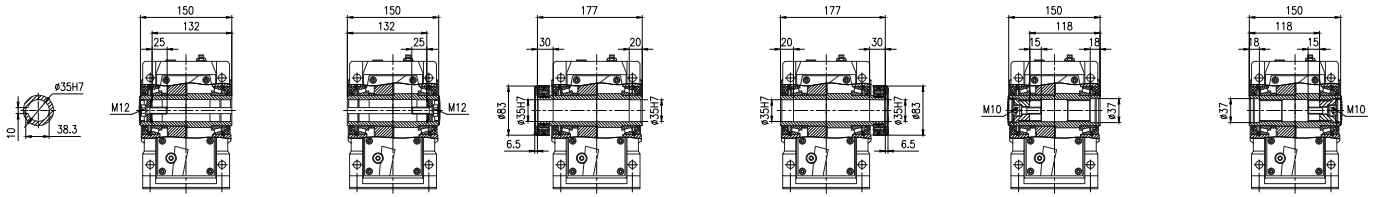

K304HG

K304HH

K304HI

K304HJ

K304HK

K304HL

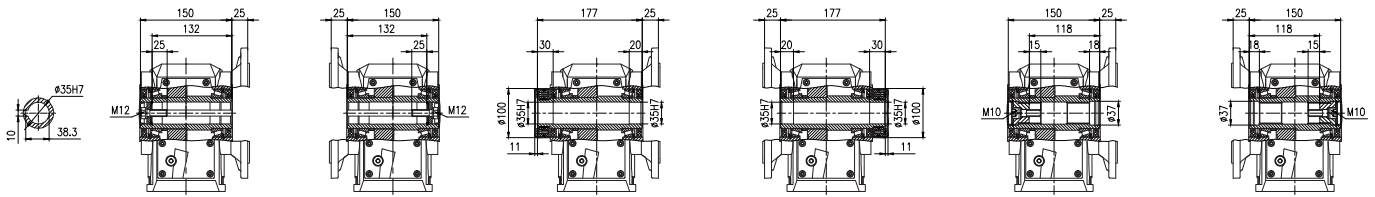

K304FG

K304FH

K304FI

K304FJ

K304FK

K304FL

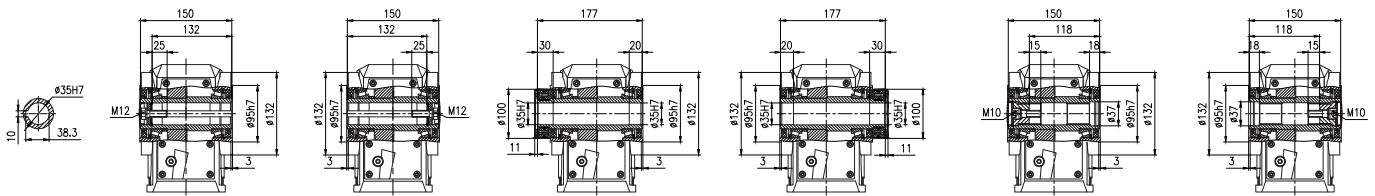

K304SG

K304SH

K304SI

K304SJ

K304SK

K304SL

K304AG

K304AH

K304AI

K304AJ

K304AK

K304AL

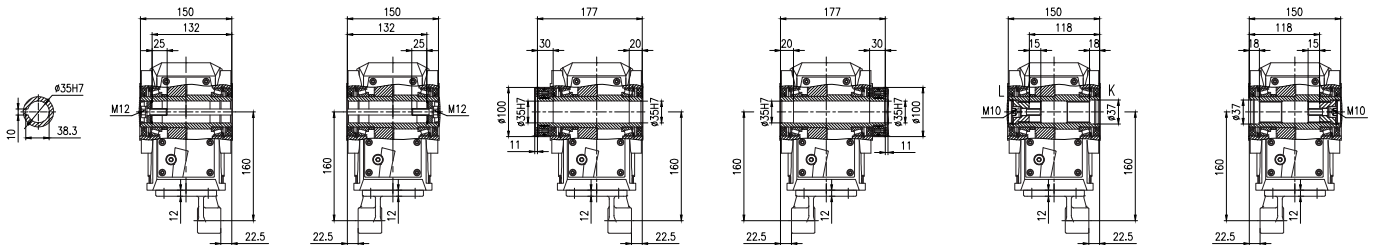

K304TG

K304TH

K304TI

K304TJ

K304TK

K304TL

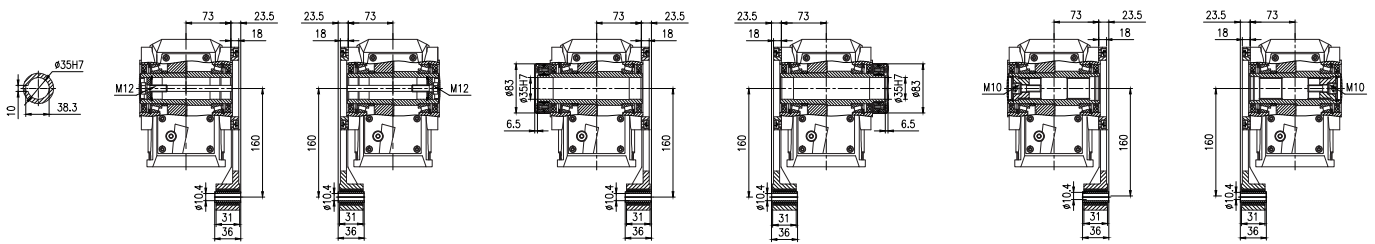

K304MG

K304MH

K304MI

K304MJ

K304MK

K304ML

K305

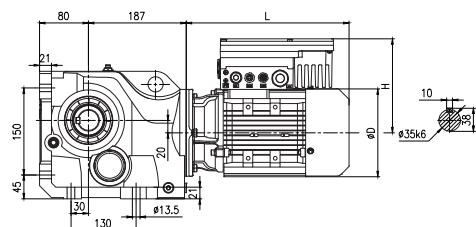

Horizontal foot-mounted H

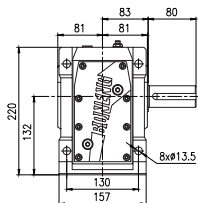

K305HA

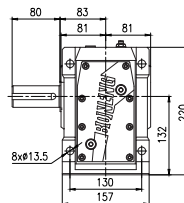

K305HB

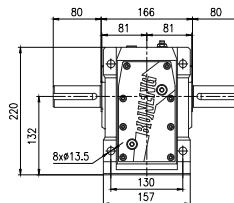

K305HC

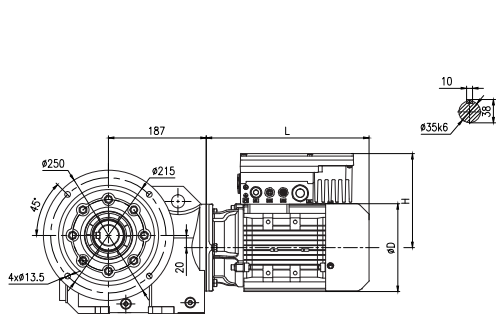

Flange-mounted F

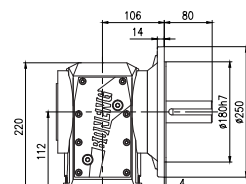

K305FA

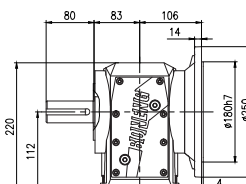

K305FB

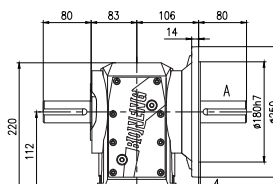

K305FC

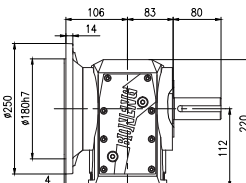

K305FD

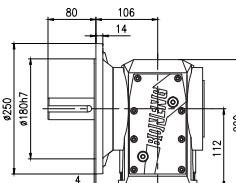

K305FE

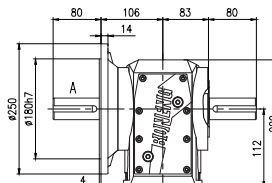

K305FF

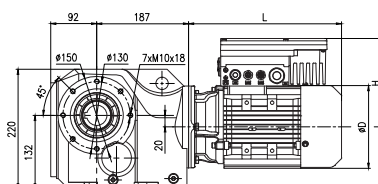

Short flange-mounted S

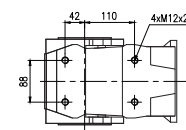

Shaft-mounted A

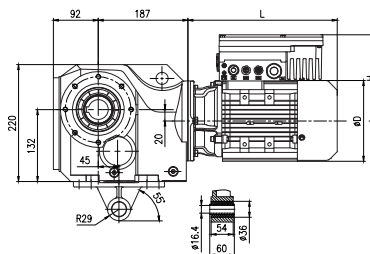

Torque arm-mounted with accessory T

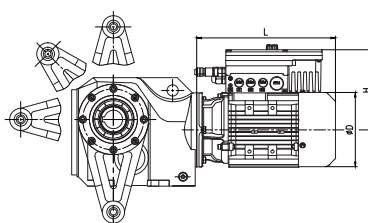

Torque arm-mounted with side accessory M

Dimension Data of Gearmotor Variable Frequency Drive All-in-one (mm) 50Hz-1500r/min							
Power of 4 pole type (kW)	Range of Ratio	MH			MP		
		L	D	H	L	D	H
0.55	90-112	300	159	173	300	159	173
0.75	63-112	300	159	173	300	159	173
1.1	50-63	323	176	188.5	323	176	188.5
1.5	40-63	323	176	188.5	348	176	188.5
2.2	28-56	395	198	191	395	198	191
3	22.4-40	395	198	191	395	198	191

K305

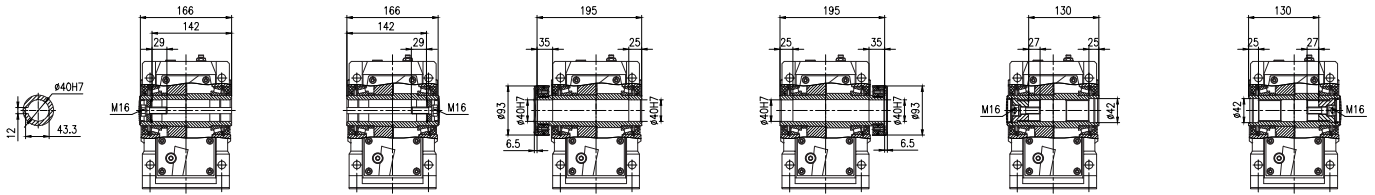

K305HG

K305HH

K305HI

K305HJ

K305HK

K305HL

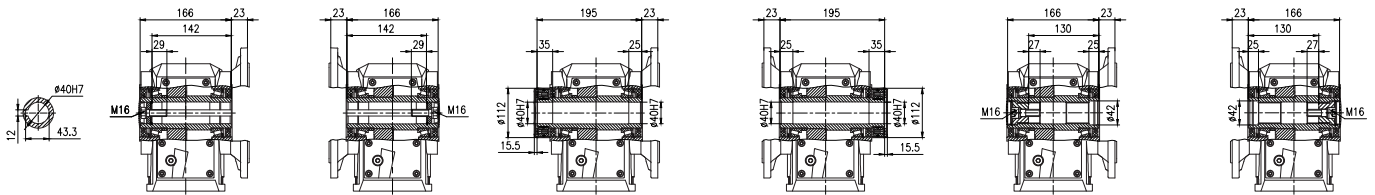

K305FG

K305FH

K305FI

K305FJ

K305FK

K305FL

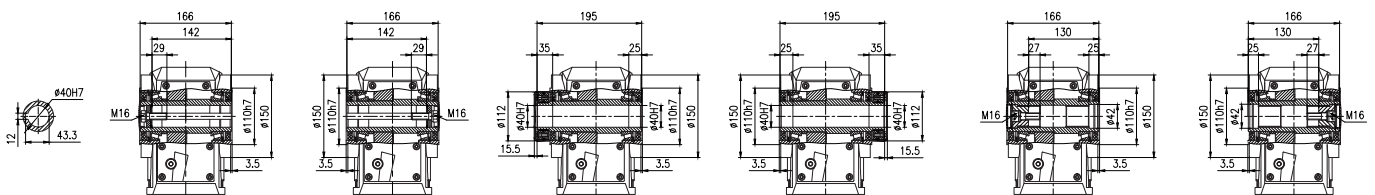

K305SG

K305SH

K305SI

K305SJ

K305SK

K305SL

K305AG

K305AH

K305AI

K305AJ

K305AK

K305AL

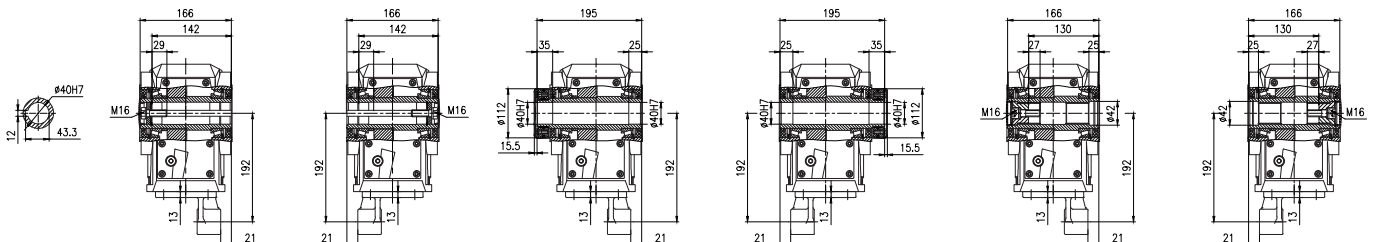

K305TG

K305TH

K305TI

K305TJ

K305TK

K305TL

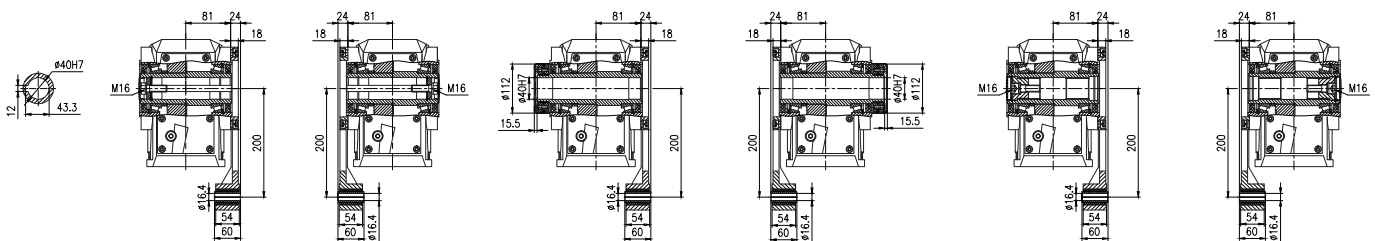

K305MG

K305MH

K305MI

K305MJ

K305MK

K305ML

K306

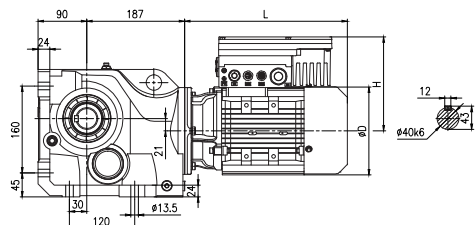

Horizontal foot-mounted H

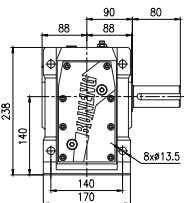

K306HA

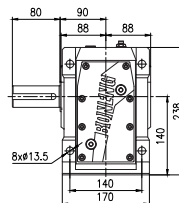

K306HB

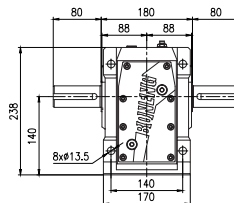

K306HC

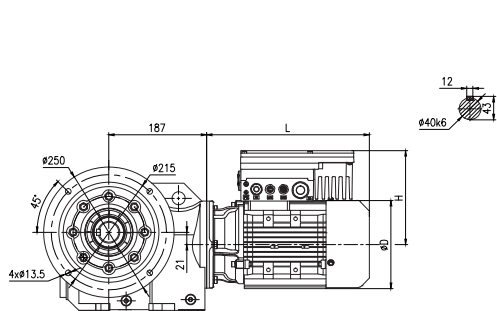

Flange-mounted F

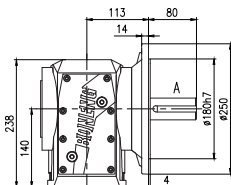

K306FA

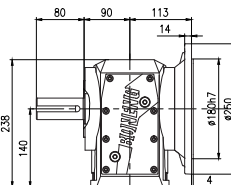

K306FB

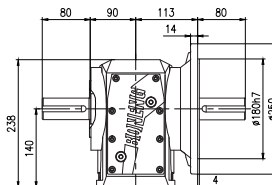

K306FC

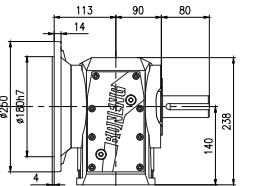

K306FD

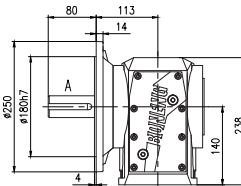

K306FE

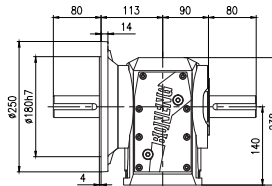

K306FF

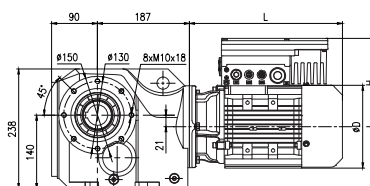

Short flange-mounted S

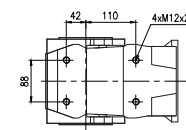

Shaft-mounted A

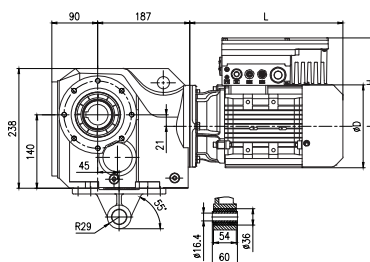

Torque arm-mounted with accessory T

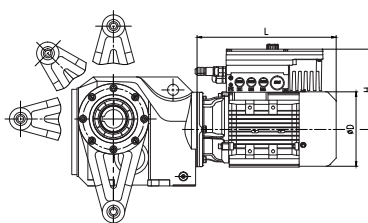

Torque arm-mounted with side accessory M

Dimension Data of Gearmotor Variable Frequency Drive
All-in-one (mm) 50Hz-1500r/min

Power of 4 pole type (kW)	Range of Ratio	MH			MP		
		L	D	H	L	D	H
0.75	100-125	300	159	173	300	159	173
1.1	63-90	323	176	188.5	323	176	188.5
1.5	56-90	323	176	188.5	348	176	188.5
2.2	40-80	395	198	191	395	198	191
3	31.5-56	395	198	191	395	198	191

K306

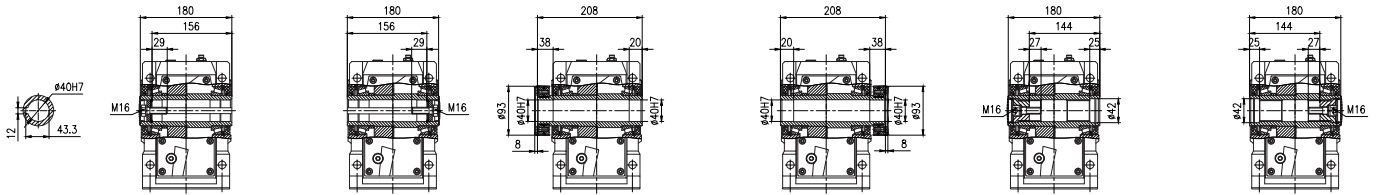

K306HG

K306HH

K306HI

K306HJ

K306HK

K306HL

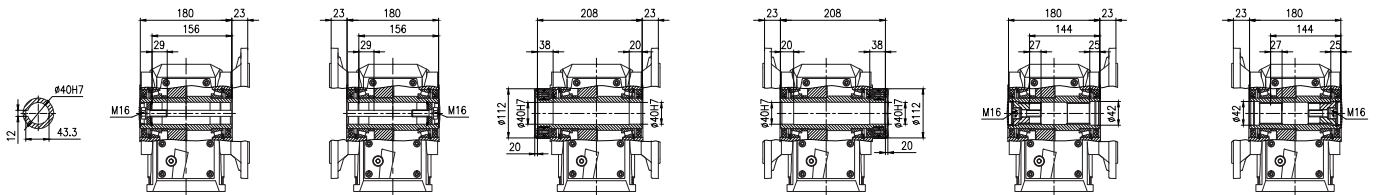

K306FG

K306FH

K306FI

K306FJ

K306FK

K306FL

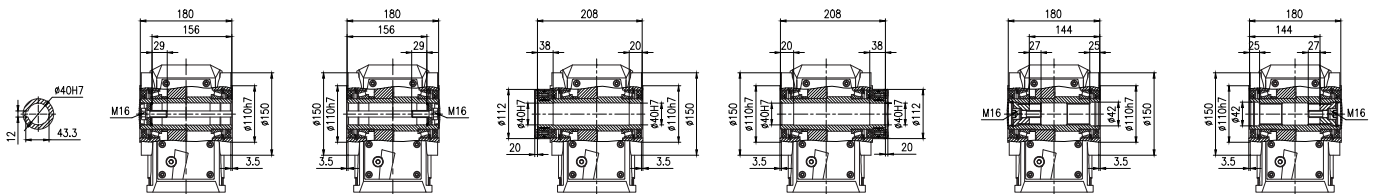

K306SG
K306AG

K306SH
K306AH

K306SI
K306AI

K306SJ
K306AJ

K306SK
K306AK

K306SL
K306AL

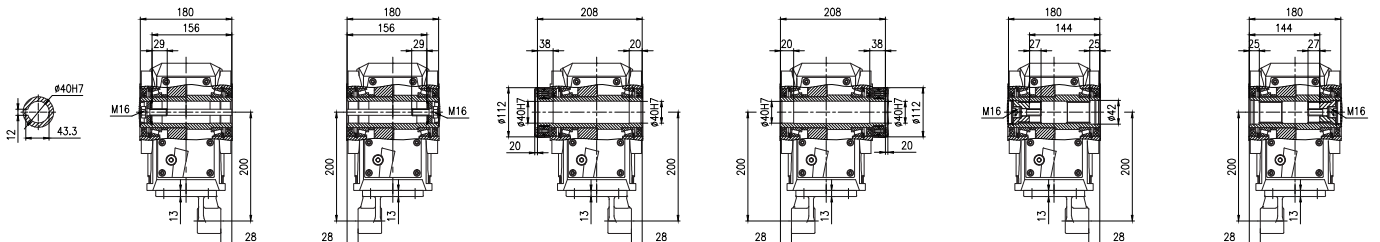

K306TG

K306TH

K306TI

K306TJ

K306TK

K306TL

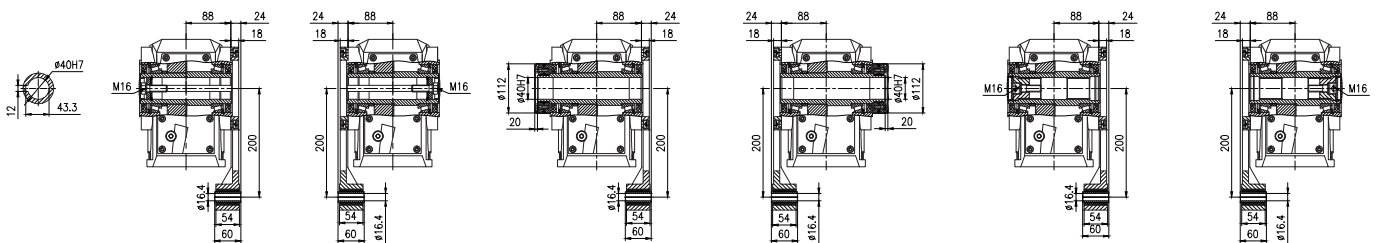

K306MG

K306MH

K306MI

K306MJ

K306MK

K306ML

K307

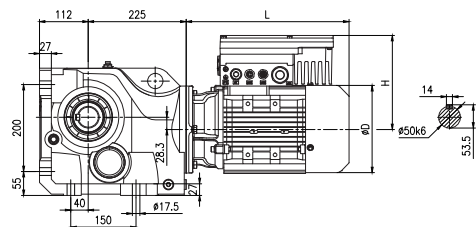

Horizontal foot-mounted H

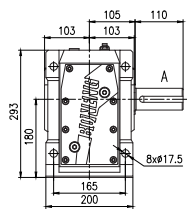

K307HA

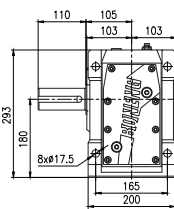

K307HB

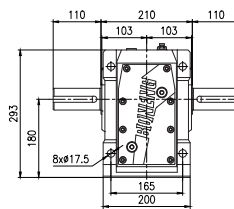

K303HC

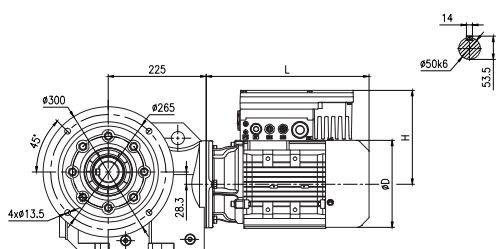

Flange-mounted F

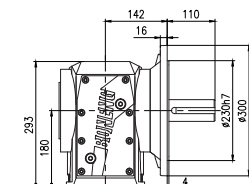

K307FA

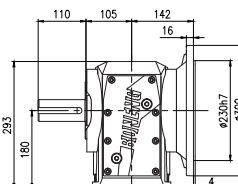

K307FB

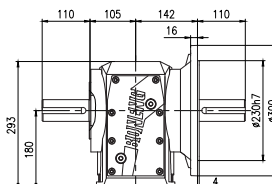

K307FC

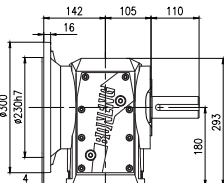

K307FD

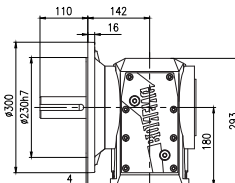

K307FE

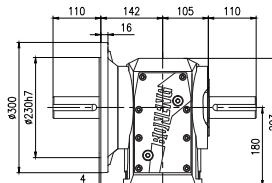

K307FF

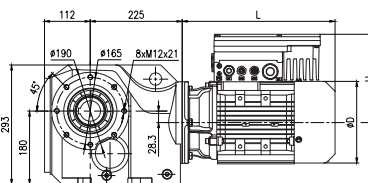

Short flange-mounted S

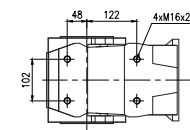

Shaft-mounted A

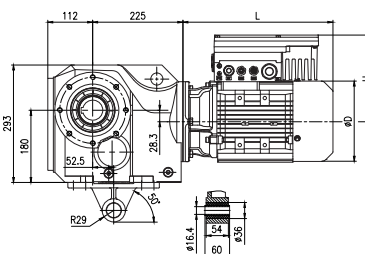

Torque arm-mounted with accessory T

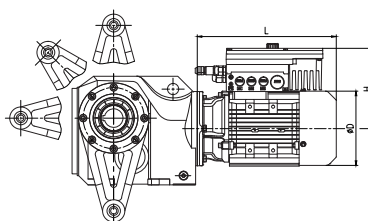

Torque arm-mounted with side accessory M

Dimension Data of Gearmotor Variable Frequency Drive
All-in-one (mm) 50Hz-1500r/min

Power of 4 pole type (kW)	Range of Ratio	MH			MP		
		L	D	H	L	D	H
1.5	90-112	314	176	188.5	339	176	188.5
2.2	71-112	387	198	191	387	198	191
3	50-112	387	198	191	387	198	191

K307

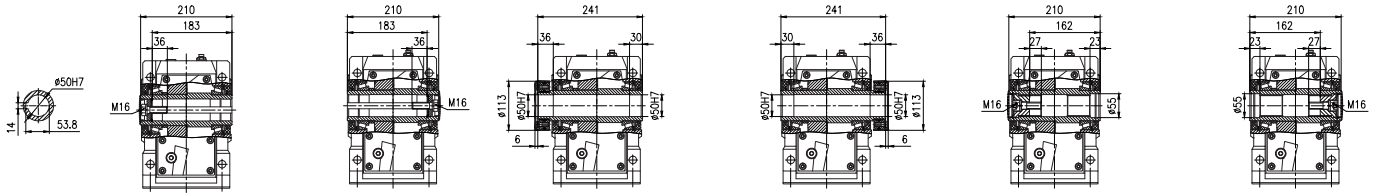

K307HG

K307HH

K307HI

K307HJ

K307HK

K307HL

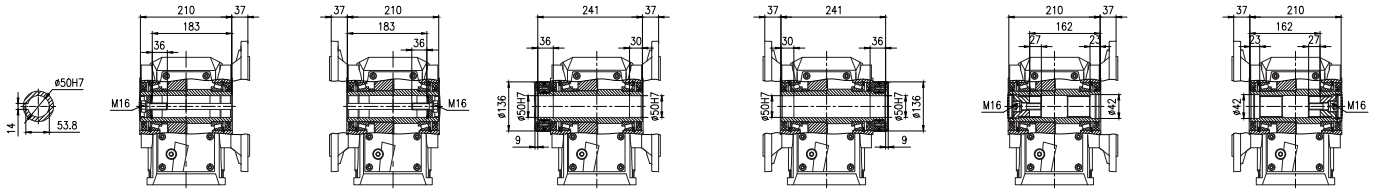

K307FG

K307FH

K307FI

K307FJ

K307FK

K307FL

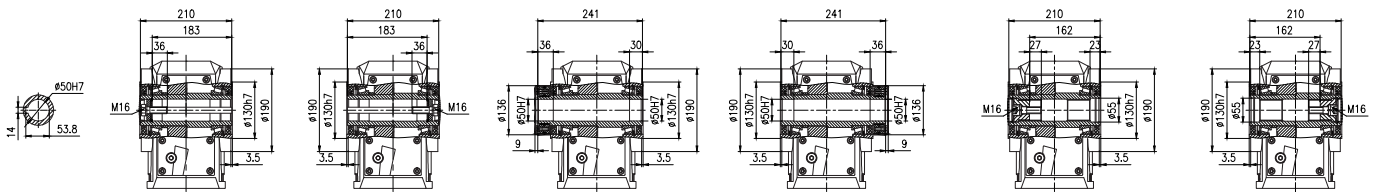

K307SG
K307AG

K307SH
K307AH

K307SI
K307AI

K307SJ
K307AJ

K307SK
K307AK

K307SL
K307AL

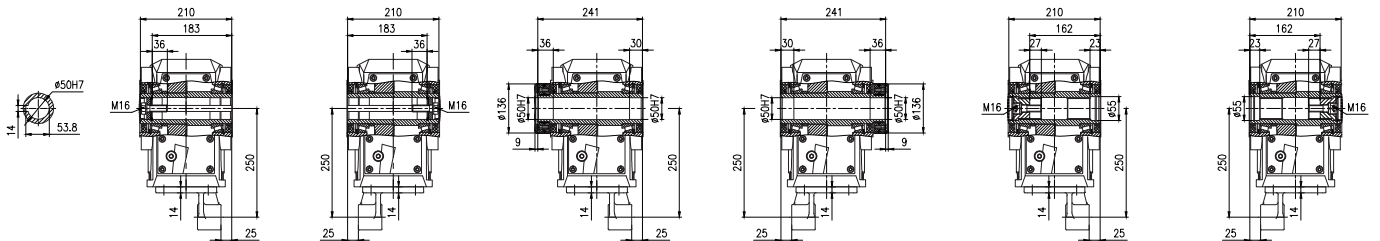

K307TG

K307TH

K307TI

K307TJ

K307TK

K307TL

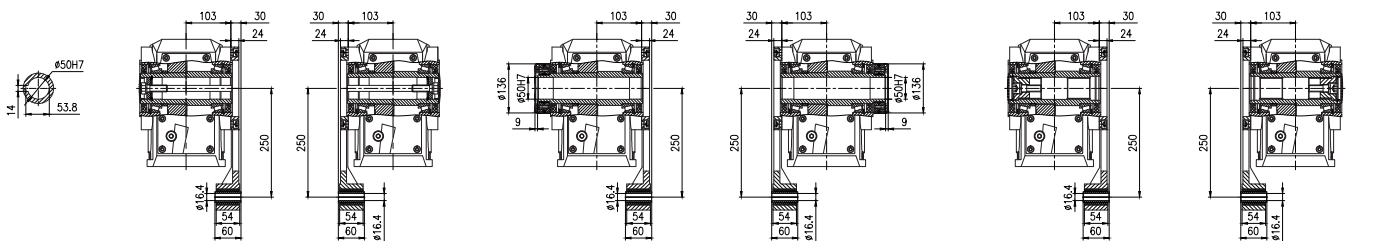

K307MG

K307MH

K307MI

K307MJ

K307MK

K307ML

K308

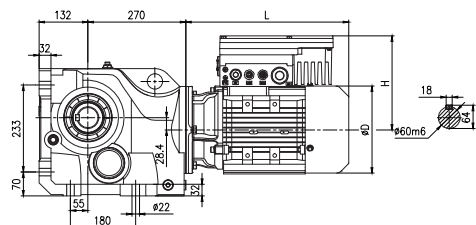

Horizontal foot-mounted H

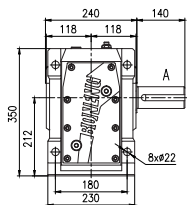

K308HA

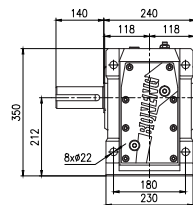

K308HB

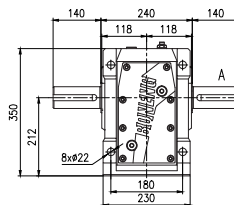

K308HC

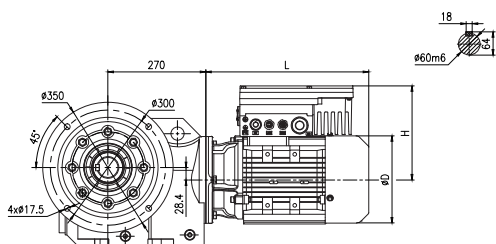

Flange-mounted F

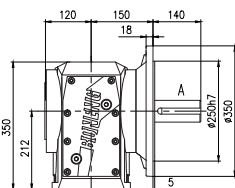

K308FA

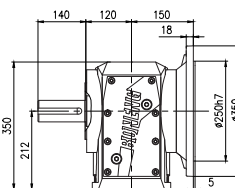

K308FB

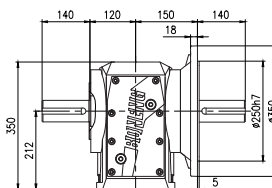

K308FC

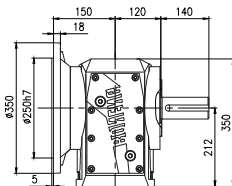

K308FD

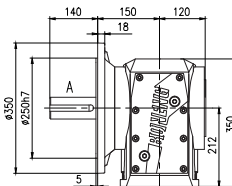

K308FE

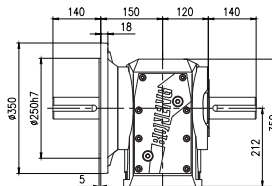

K308FF

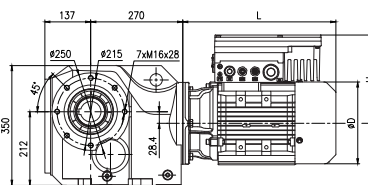

Short flange-mounted S

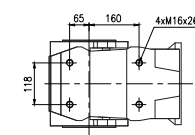

Shaft-mounted A

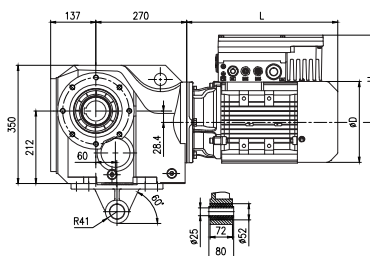

Torque arm-mounted with accessory T

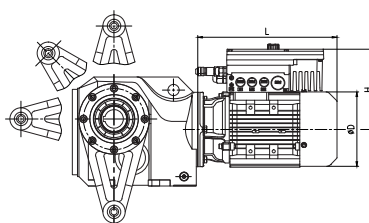

Torque arm-mounted with side accessory M

Dimension Data of Gearmotor Variable Frequency Drive
All-in-one (mm) 50Hz-1500r/min

Power of 4 pole type (kW)	Range of Ratio	MH			MP		
		L	D	H	L	D	H
2.2	112-160	378	198	191	378	198	191
3	90-160	378	198	191	378	198	191

K308

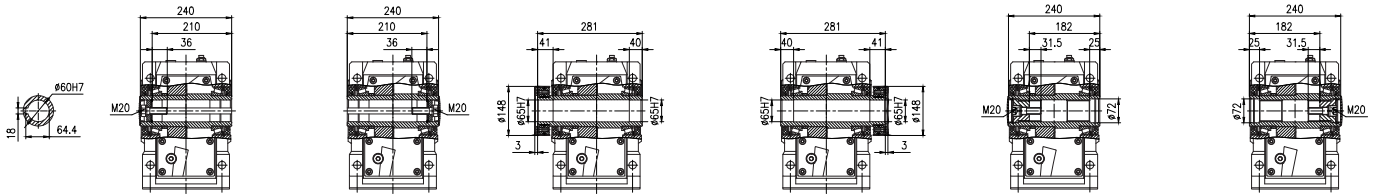

K308HG

K308HH

K308HI

K308HJ

K308HK

K308HL

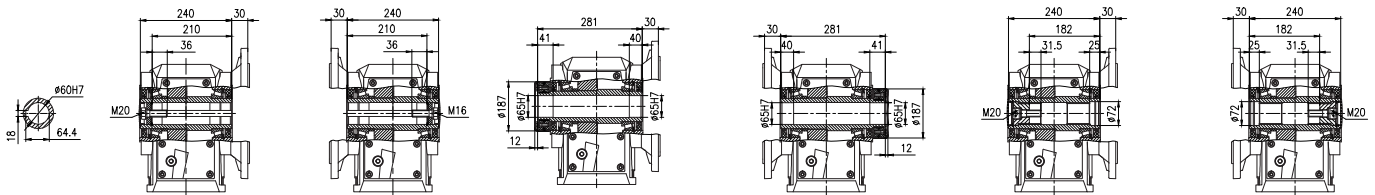

K308FG

K308FH

K308FI

K308FJ

K308FK

K308FL

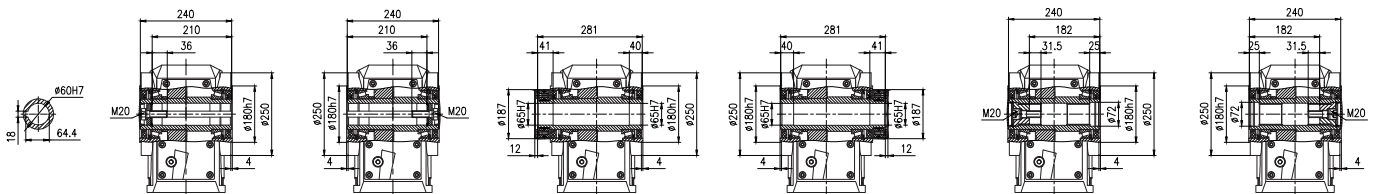

K308SG
K308AG

K308SH
K308AH

K308SI
K308AI

K308SJ
K308AJ

K308SK
K308AK

K308SL
K308AL

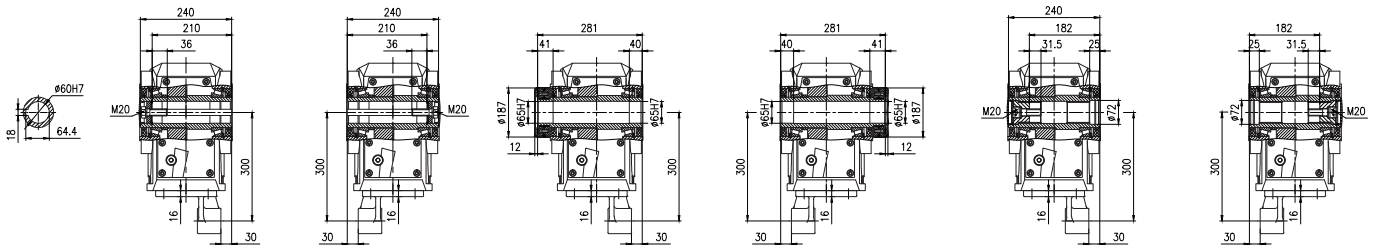

K308TG

K308TH

K308TI

K308TJ

K308TK

K308TL

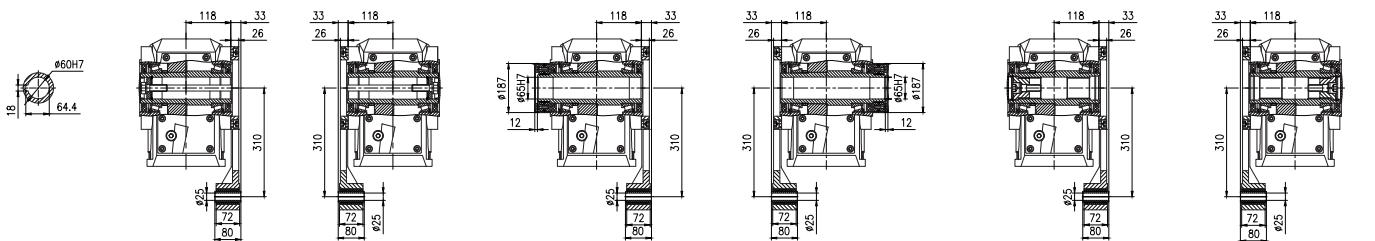

K308MG

K308MH

K308MI

K308MJ

K308MK

K308ML

**7.允许的输出轴径向力
Fr2(N)**

**7.Permissible Radial Force
of Output Shaft Fr2(N)**

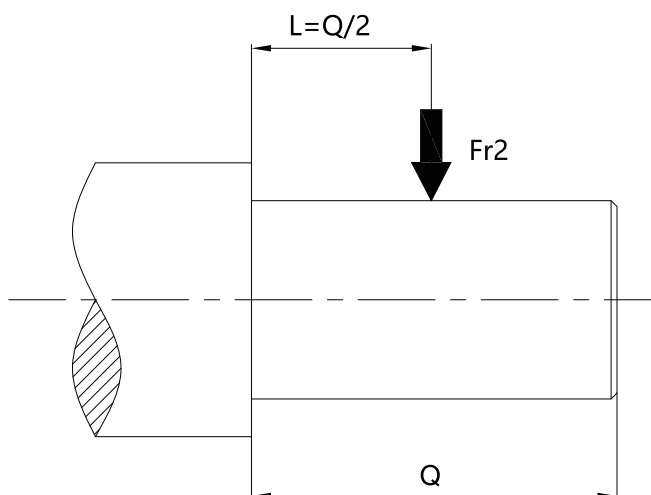

n _{2N} (r/min)	Fr ₂ (N)					
	K303	K304	K305	K306	K307	K308
315~425	1466	2430	4330	7715	/	/
280~315	1600	2650	4720	8410	/	/
225~280	1750	2890	5150	9165	/	/
160~225	1899	3150	5609. 6791	9990	11135	12150
140~160	2070	3240	5790. 8549	10350	12510	12780
125~140	2250	3510	6105. 4238	10620	12960	13410
112~125	2340	3348	6087. 8863	11070	13590	13320
90~112	2430	3510	6001. 0499	10260	13500	13770
80~90	2610	3807	6139. 1612	9900	14490	14670
71~80	2799	3960	6204. 1277	9720	14130	15120
63~71	2880	4239	6418. 9625	9720	13860	16110
56~63	2997	4500	6489. 9923	9360	13860	16200
50~56	3150	4770	6649. 6541	9270	13860	16650
45~50	3285	5040	6835. 2615	9270	13860	17280
35. 5~45	3375	5328	7027. 8418	9270	13860	19260
31. 5~35. 5	3960	5328	7027. 8418	9270	13860	20520
28~31. 5	4194	5328	7027. 8418	9270	13860	21150
25~28	4410	5328	7027. 8418	9270	13860	22500
22. 4~25	4662	5328	7027. 8418	9270	13860	23580
20~22. 4	4968	5328	7027. 8418	9270	13860	24570
18~20	5076	5328	7027. 8418	9270	13860	24570
16~18	5076	5328	7027. 8418	9270	13860	24570
≤16	5076	5328	7027. 8418	9270	13860	24570

8.被驱动轴推荐尺寸(mm)

8.Recommended Dimensions for Driven Equipment Shaft (mm)

8.1锁紧盘

8.1 Shrink Disk

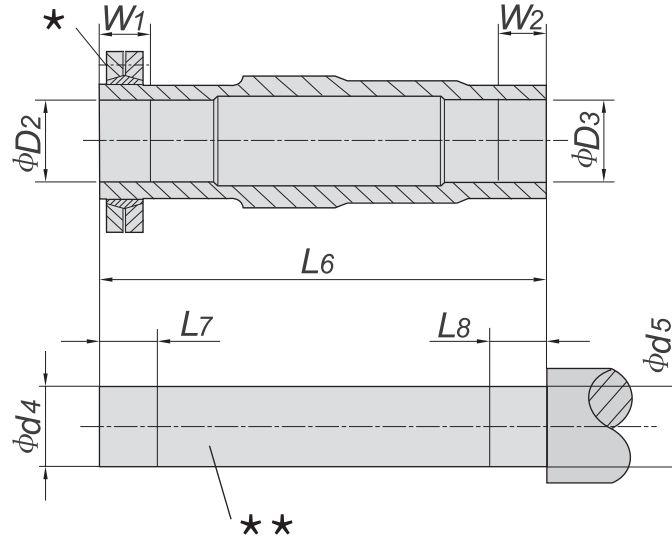

	D2	D3	d4	d5	L6	L7	L8	W1	W2	锁紧盘 型号 Shrink Disk Type	锁紧盘 螺栓 Shrink Disk Bolt	锁紧盘 重量(kg) Shrink Disk Weight (kg)
K303	30H7	30H7	30h6	30h6	146	35	25	30	20	SP2-44×80	M6	0.6
K304	35H7	35H7	35h6	35h6	177	35	25	30	20	SP2-44×80	M6	0.6
K305	40H7	40H7	40h6	40h6	195	40	30	35	25	SP2-50×90	M6	0.8
K306	40H7	40H7	40h6	40h6	208	43	25	38	20	SP2-50×90	M6	0.8
K307	50H7	50H7	50h6	50h6	241	41	35	36	30	SP2-62×110	M6	1.3
K308	65H7	65H7	65h6	65h6	281	46	45	41	40	SP2-80×145	M8	1.9

★ 螺栓

★ Bolt

★★ 被驱动轴

★★ Driven Equipment Shaft

8.2花键轴

8.2 Involute Spline

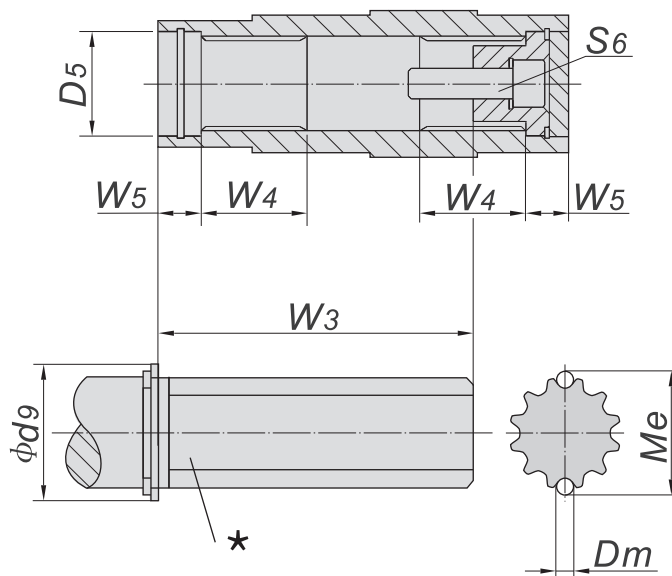

	渐开线花键参数DIN5480 模数x齿数x压力角x大径x9H Involute spline size DIN 5480 m x Z x α x D x 9H	D5	Dm	d9	Me	W3	W4	W5	S6
K303	1.25x22x30x30x9H	37	2.75	42	33.03	85	25	18	M10X30
K304	2x16x30x35x9H	37	4	42	38.92	115	32	18	M10X30
K305	2x16x30x35x9H	42	4	47	38.92	125	42	25	M16X40
K306	2x16x30x35x9H	42	4	47	38.92	140	42	25	M16X40
K307	2x24x30x50x9H	55	4	62	54.13	160	52	23	M16X50
K308	2x31x30x65x9H	72	4	82	68.96	180	62	25	M20X60

★ 被驱动轴

★ Driven Equipment Shaft

9.轴端C型螺纹中心孔

9.Type C screw central hole in shaft end

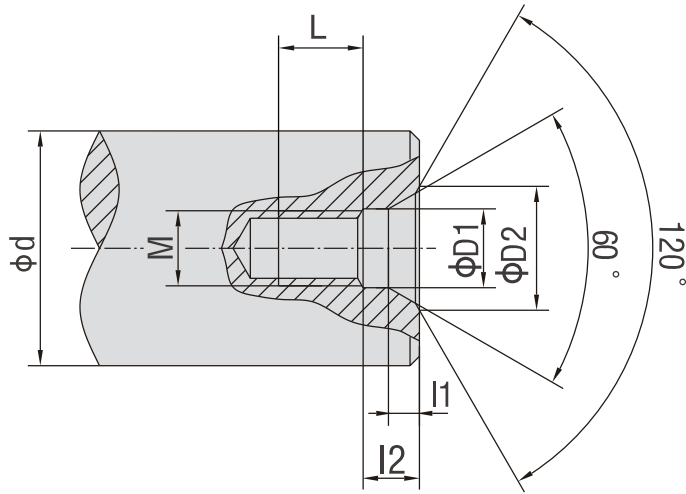

d	M	L	l2	l1	D1	D2
7 < d ≤ 10	M3	10	2.6	1.8	3.2	5.8
10 < d ≤ 13	M4	10	3.2	2.1	4.3	7.4
13 < d ≤ 16	M5	10	4	2.4	5.3	8.8
16 < d ≤ 21	M6	12	5	2.8	6.4	10.5
21 < d ≤ 24	M8	12	6	3.3	8.4	13.2
24 < d ≤ 30	M10	15	7.5	3.8	10.5	16.3
30 < d ≤ 38	M12	20	9.5	4.4	13	19.8
38 < d ≤ 50	M16	25	12	5.2	17	25.3
50 < d ≤ 85	M20	30	15	6.4	21	31.3
85 < d ≤ 130	M24	35	18	8	25	38
130 < d ≤ 225	M30	45	18	11	31	48

**10.平键与键槽的尺寸
(mm)**

**10. Dimension of Parallel
Key and Keyway(mm)**

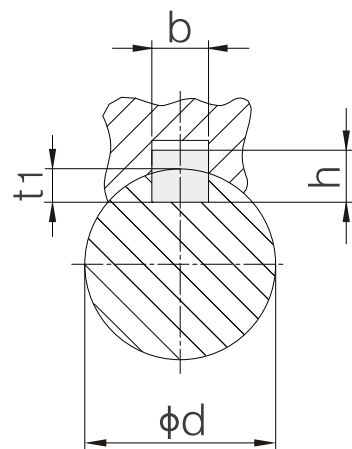
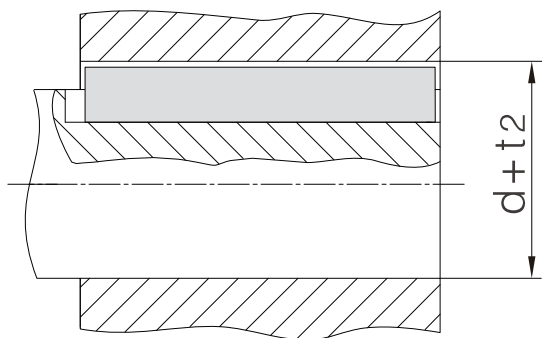

d	b	h	t ₁	d + t ₂
8 < d ≤ 10	3	3	1.8	d + 1.4
10 < d ≤ 12	4	4	2.5	d + 1.8
12 < d ≤ 17	5	5	3	d + 2.3
17 < d ≤ 22	6	6	3.5	d + 2.8
22 < d ≤ 30	8	7	4	d + 3.3
30 < d ≤ 38	10	8	5	d + 3.3
38 < d ≤ 44	12	8	5	d + 3.3
44 < d ≤ 50	14	9	5.5	d + 3.8
50 < d ≤ 58	16	10	6	d + 4.3
58 < d ≤ 65	18	11	7	d + 4.4
65 < d ≤ 75	20	12	7.5	d + 4.9
75 < d ≤ 85	22	14	9	d + 5.4
85 < d ≤ 95	25	14	9	d + 5.4
95 < d ≤ 110	28	16	10	d + 6.4
110 < d ≤ 130	32	18	11	d + 7.4
130 < d ≤ 150	36	20	12	d + 8.4
150 < d ≤ 170	40	22	13	d + 9.4
170 < d ≤ 200	45	25	15	d + 10.4
200 < d ≤ 230	50	28	17	d + 11.4
230 < d ≤ 260	56	32	20	d + 12.4

11. 可选附件和指定配置

11.1 齿轮常规安装 常规供货无需说明

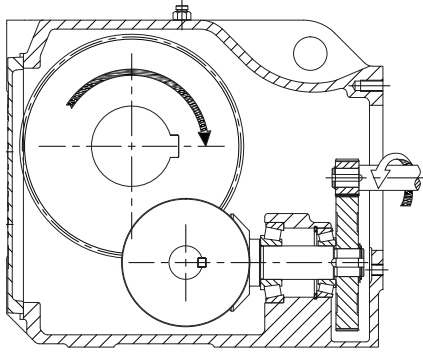

11. Accessories and Specific Configuration

11.1 Conventional Installation of Gear Standard Installation do not have to be indicated

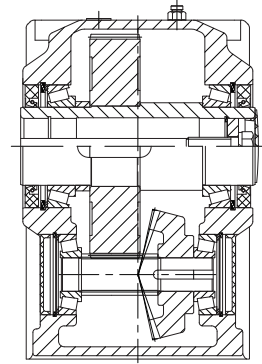

11.2 齿轮非常规安装

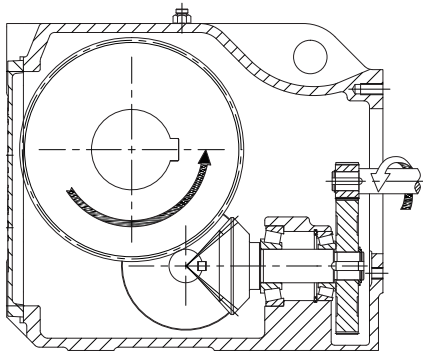

11.2 Unconventional Installation of Gear

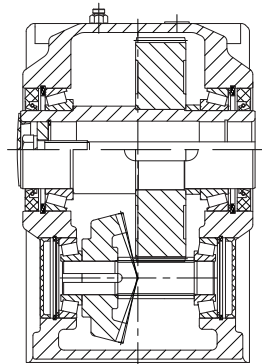

11.3 补偿油箱 (代号6)

齿轮马达在以下工况时建议采用补偿油箱浸油润滑。

1. 在安装方位为D4且长时间连续运转时，建议配置补偿油箱；
2. 在安装方位为D5/D6时，出厂已配置补偿油箱；

11.3 Oil Compensating Tank (Code 6)

Oil compensating tank lubrication is recommended for gearmotor under working conditions below.

1. Oil compensating tank is recommended for gearmotors with D4 installation position and long duration continuous operation;
2. Oil compensating tank has been equipped for gearmotors with D5 or D6 installation position before delivery.

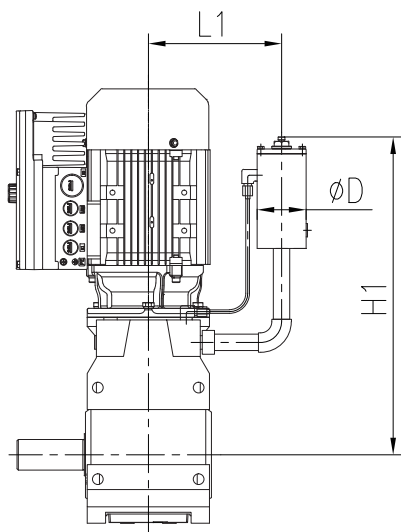

D4

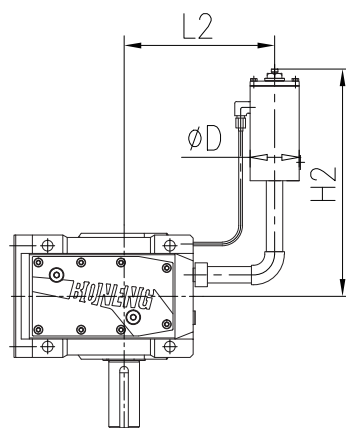

D5

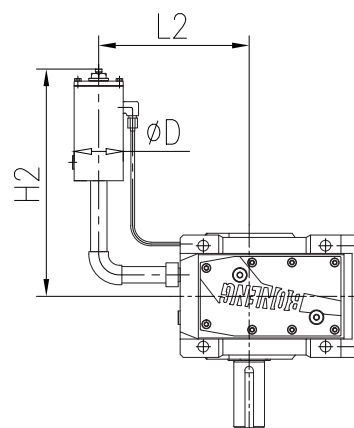

D6

	D	L1	H1	L2	H2
K303	42	100	315	170	165
K304	42	115	340	175	170
K305	42	120	345	190	165
K306	42	120	345	200	170
K307	80	160	520	290	270
K308	80	175	585	315	275

**12.不同安装方位
的润滑油用量(L)**

**12.The oil quantities on
different mounting positon(L)**

	D1	D2	D3	D4	D5	D6
K303	0.8	0.8	0.7	0.9	0.8	0.8
K304	1.2	1.1	1.2	1.6	1.3	1.3
K305	2.2	1.7	1.2	2.5	2.1	2.1
K306	2.2	1.6	1.6	2.6	1.9	1.9
K307	2.9	3.9	3.1	5.4	4.5	4.5
K308	5.2	6.6	8	10	8	8

13.重量表

13. Weight

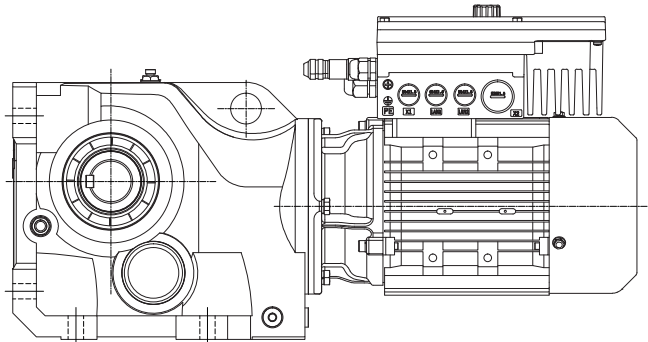

K303	K304	K305	K306	K307	K308			
14	23	32	39	67	108			
	071M	071M	080M	080M	090S	090M	100M	100M
	0.25	0.37	0.55	0.75	1.1	1.5	2.2	3
MH	8	9	14	15	18	19	30	33
MP	9	10	15	16	21	23	32	36

随着技术迭代进步，博能产品样本将会同步更新，请谅解。
Along with the technology advancedet.,the product of
the manual of Boneng will be changed,please forgive.

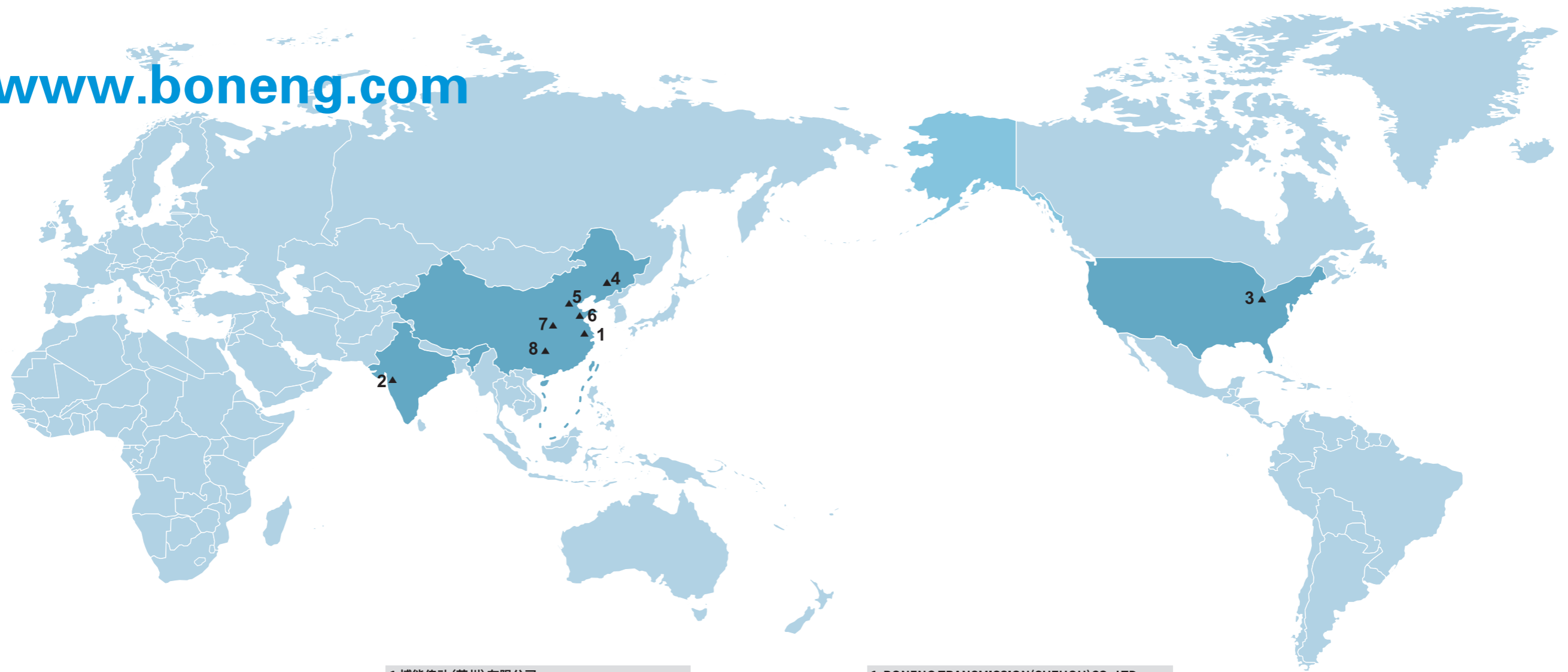

1 博能传动(苏州)有限公司
江苏省苏州市相城区如元路100号 215131
TEL: 0512-66189662

2 博能传动(印度)有限公司
Plot No. E-10/3, MIDC sinnar (Malegaon)
Industrial Area, Nashik, 422123,
Maharashtra, India.
TEL:+91-11- 4507 6293 (DELHI)
TEL:+91-22-2781 3385 (MUMBAI)

3 博能传动(美国)有限公司
1250 E 222nd Euclid, OH 44117,United Staes
TEL: 1-216-618-3099
TEL: 1-216-618-0138

4 博能传动(沈阳)有限公司
沈阳市沈北新区太平洋工业城A区A73-6号 110013
TEL: 024-31271571

5 博能传动(天津)有限公司
天津市北辰区双海道6号宏鹏工业园7号车间 300021
TEL: 022-26929556

6 博能传动(潍坊)有限公司
山东省潍坊市安丘市经济开发区汶水路与
昆仑大街交叉口往北100米路东1号车间 261000
TEL: 0536-2141166

7 博能传动(开封)有限公司
河南省开封市宋城路四大街11号海神机械院内五号厂房 475000
TEL: 0371-23335238

8 博能传动(长沙)有限公司
长沙市望城经济开发区普瑞大道1288号 410205
TEL: 0731-88386958

1 BONENG TRANSMISSION(SUZHOU)CO.,LTD.
No. 100, Ruyuan Road, Xiangcheng District, 215131
Suzhou, Jiangsu Province, China
TEL: 0512-66189662

2 BONENG TRANSMISSION(INDIA)PVT.LTD
Plot No. E-10/3, MIDC sinnar (Malegaon)
Industrial Area, Nashik, 422123,
Maharashtra, India.
TEL:+91-11- 4507 6293 (DELHI)
TEL:+91-22-2781 3385 (MUMBAI)

3 BONENG TRANSMISSION(USA)LLC.
1250 E 222nd Euclid, OH 44117,United Staes
TEL: 1-216-618-3099
TEL: 1-216-618-0138

4 BONENG TRANSMISSION(SHENYNG)CO.,LTD.
No. A73-6, Area A, Pacific Industrial City, Shenbei 110013
New District, Shenyang, Liaoning Province, China
TEL: 024-31271571

5 BONENG TRANSMISSION(TIANJIN)CO.,LTD.
7th Workshop, Hongpeng Industrial Park, No.6
Shuanghai Road, Beichen District, Tianjin City,China 300021
TEL: 022-26929556

6 BONENG TRANSMISSION(WEIFANG)CO.,LTD.
1st Workshop, Economic Development Zone, Anqiu, 261000
Weifang City, Shandong Province, China
TEL: 0536-2141166

7 BONENG TRANSMISSION(KAIFENG)CO.,LTD.
5th Workshop, Haishen Machinery, No.11, Fourth
Street, Songcheng Road,New District, Kaifeng City,
Henan Province, China 475000
TEL: 0371-23335238

8 BONENG TRANSMISSION(CHANGSHA)CO.,LTD.
No. 1288 Puri Avenue, Wangcheng Economic Development
Zone, Changsha City, Hunan Province, China 410205
TEL: 0731-88386958

BONENG

BONENG